

# *TECHNICAL INFORMATION*

---

**CITIZEN QUARTZ**

**Cal. No. 35❖❖**



(Cal. No. 3530)



(Cal. No. 3570)

## 51. OUTLINE

CAL. No. 3510※: Chronograph/Timer with alarm and date indication mechanism

CAL. No. 3530※/3531※: Chronograph/Timer with alarm

CAL. No. 3560※: Chronograph/Timer with date indication mechanism

CAL. No. 3570※: Chronograph with the indicator of the age of the moon.

## 52. SPECIFICATIONS

Cal. Nos.		3510A-12	3530A/3531A-12	3560A-12	3570A-12
Type		Analog quartz watch with a center second + 3 small hands			
Module size (mm)		φ30.8 x 4.1t	φ30.8 x 3.6t	φ30.8 x 4.1t	
Accuracy		±15 sec/month (at normal temperature)			
Oscillation		32,768Hz			
Integrated circuit		C/MOS-LSI (1 unit)			
Effective temperature range		-10°C ~ +60°C (14°F ~ 140°F)			
Converter		Bipolar step motor (3 units)			
Adjustment of time rate		2 digital frequency control terminals (for market)			
Measurement gate		10 sec.			
Additional functions	Chronograph	Yes Unit: 2/100 sec. (Indication of 2/100 second, second, minute and hour), Max. indication: 11 hours, 59 minutes, 59 seconds, 98/100 second			
	Timmer	Yes Set by 1 minute (49-minute meter)			
	Counter	Yes 50-unit counter (Timer display is used.)			
	Alarm	Yes 12-hour system		No	
	Date quick setting device	Yes	No	Yes	No
	The age of the moon quick setting device	No	No	No	Yes 59 days/rotation
	Power saving switch	Yes			
	Alarm monitor	Yes		No	
	Electro-magnetic correction mechanism	Yes			
	Second hand zero-reset mechanism	Yes			
Battery	Parts No.	280-44	Cell code	SR927W	
	Size	φ9.5mm x 2.7t mm			
	Voltage	1.55V	Capacity	55mAH	
	Lifetime	Approx. 2 years (on the condition that alarm is used for 20 sec/day and that the CG 2/100 sec hand operates three times a day for more than 3 minutes each.			
Current consumption	Normal time indication		3.0μA max.		
	Chronograph operation (2/100 sec. CG hand operates)		80μA max.		
	Unit of electronic circuit		0.5μA max.		
Coil resistance	Coil	0.8 ~ 1.3KΩ		Second coil	1.7 ~ 2.1KΩ
	CG Coil	2.4 ~ 3.0KΩ			

### 53. HANDLING METHOD

Operate each button securely

#### 3-1. Name and function of each part

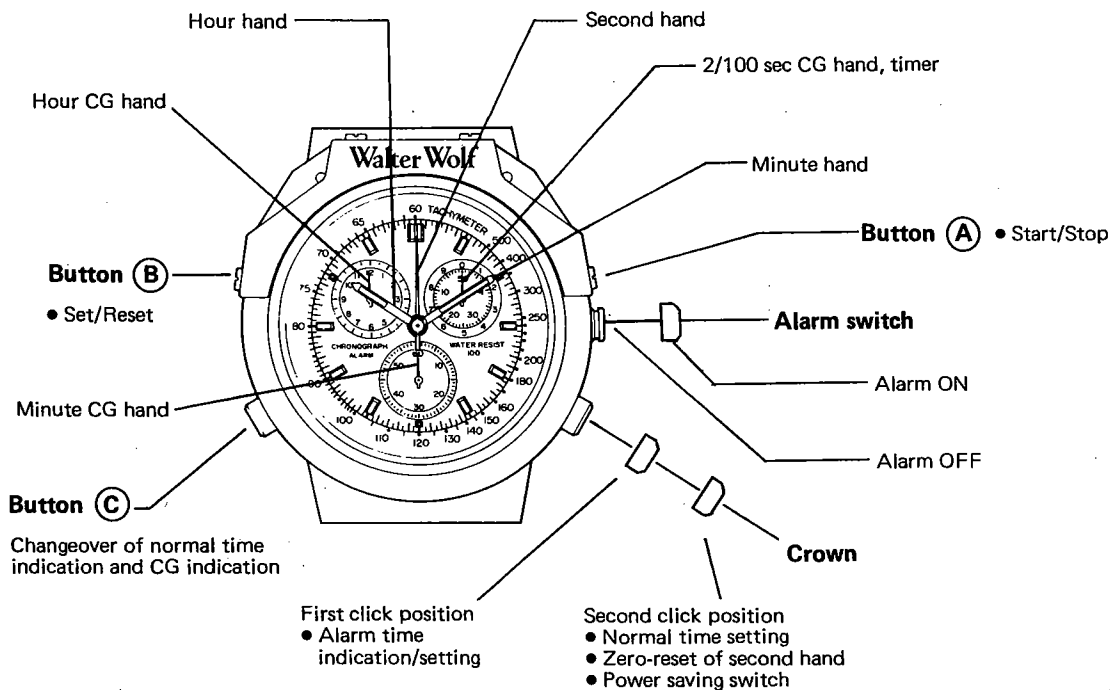

**CAL. 3530/3531**

- \* CAL. No. 3510 is the same as above CAL.No. 3530/3531, except that it is equipped with the date indicator (in the direction of 6 o'clock).
- \* CAL. No. 3560 is the same as above CAL.No. 3530/3531, except that it is equipped with the date indicator (in the direction of 6 o'clock) and is not equipped with the alarm.
- \* CAL. No. 3570 is the same as above CAL.No. 3530/3531, except that it is equipped with the age of the moon indicator (in the direction of 6 o'clock) and is not equipped with the alarm.

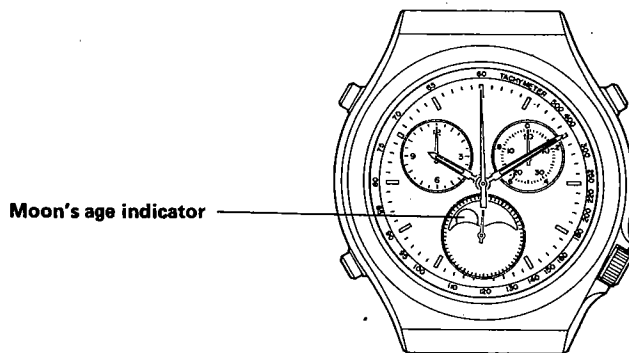

**CAL. 3570**

The moon can be seen at various positions as shown below.

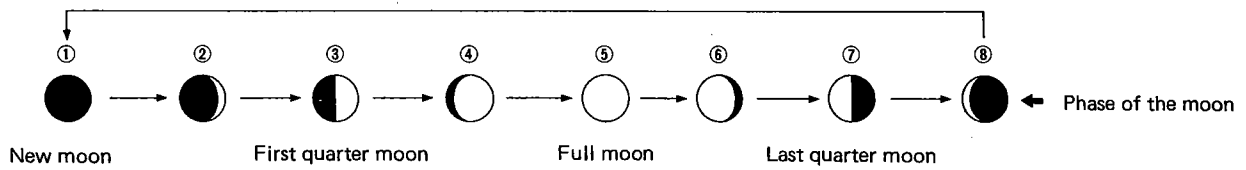

The moon waxes and wanes repeatedly in order of ① – ⑧ – ① .

- What is the age of the moon  
The time from a new moon indicated on the unit of day. The average period from a new moon to the next new moon is equivalent to about 29.5 days.

**(3) How to read the age of the moon (Example of indication)**

①	New moon Age of the moon: 0 (Spring tide)	③	First quarter moon Age of the moon: Approx. 7 (Neap tide)
⑤	Full moon Age of the moon: Approx. 15 (Spring tide)	⑦	Last quarter moon Age of the moon: Approx. 22 (Neap tide)

\* The level of the tide can be seen from the indicated age of the moon.

The age of the moon can be set more accurately if it is set when it is the New moon (the moon mark cannot be seen at all; the age of the moon is 0) or the Full moon (the moon mark is at the top (position of 12 o'clock); the age of the moon is 15).

### 3-5. Display changeover between normal time and chronograph

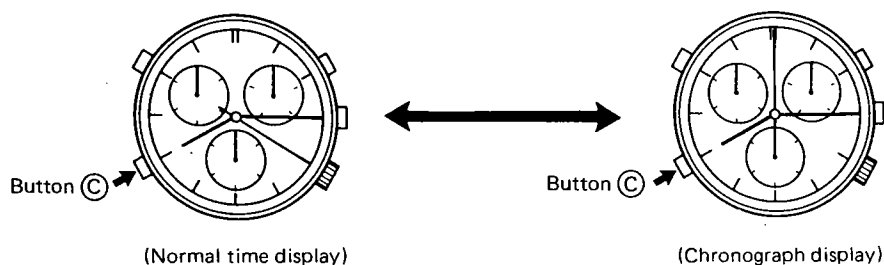

- When the button **C** is pressed in the normal time display, a confirmation sound is heard. Then, the second hand quickly advances and stops at the 0 position, thus showing the chronograph display.
- When the button **C** is pressed in the chronograph display, a confirmation sound is heard. Then, the CG 2/100 sec. hand, CG minute hand and CG hour hand come to the 0 position and the second hand changes into the normal time indicator.

### 3-6. Setting of normal time

Setting should be made with the crown pulling out to the second clicking position.

Second ----- (1) If the crown is pulled out to the second clicking position, the second hand will instantaneously come to the 0 position.

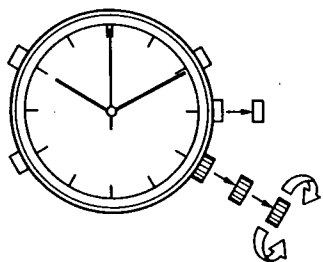

- When the second hand stands at between 0 and 29 seconds, the minute display will remain as before.
- When the second hand stands at between 30 and 59 seconds, the minute display will increase by 1 minute.
- \* In case the second hand does not come to the 0 position even if the crown is pulled out to the second clicking position, set the second hand to the 0 position by pushing the button **A** with the crown pulling out to the second clicking position. (A push of the button **A** moves the second hand by one second mark.)

Hour, minute ----- (2) If the crown is turned clockwise, the hands will go round counterclockwise. If the crown is turned counterclockwise, the hands will go round clockwise.

- Quick setting of time is possible by quickly turning the crown. If you want to stop the quick setting, turn the crown slowly.
- \* Setting should be made so that the hands stand at the 0 position.

(3) The watch starts running when the crown is pushed back.

If the hands do not start from the 0 position, alarm sounds for 20 seconds before or after the set time. (CAL. 3510/353\*)

(Note) Confirm the alarm set time after normal time is set. (CAL. 3510/353\*)

### 3-7. Using method of the chronograph

#### 1) Normal use

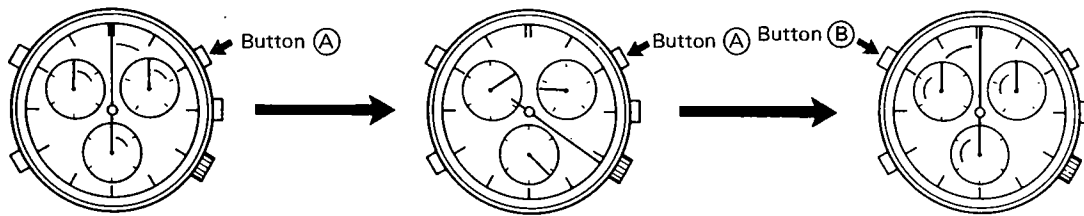

##### ① (Start)

If the button (A) is pressed in the chronograph display, (a confirmation sound is heard ... Cal. 3530/353X). Then, the CG 2/100 second hand, second hand, CG minute hand and CG hour hand operate. The CG 2/100 second hand runs for 3 minutes after starting to run and then it keeps standing at the 0 position.

Despite this, it continues measuring after it stops.

Counting up to 11 hr. 59 min. 59 sec. 98.

##### ② (Stop)

If the button (A) is pressed while the chronograph is operating, (a confirmation sound is heard ... Cal. 3510/353X). Then, the CG 2/100 second hand, second hand, CG minute hand and CG hour hand stop running. The CG 2/100 second hand, which has kept standing at the 0 position for 3 minutes after the start, runs until it reaches the time to be measured and displays it.

##### ③ (Return to the 0 position)

If the button (B) is pressed while the chronograph stops operating, the CG 2/100 second hand, CG second hand, CG minute hand and CG hour hand will return to the 0 position and keep standing there.

#### 2) Using method of the chronograph when it is used as an integrating meter

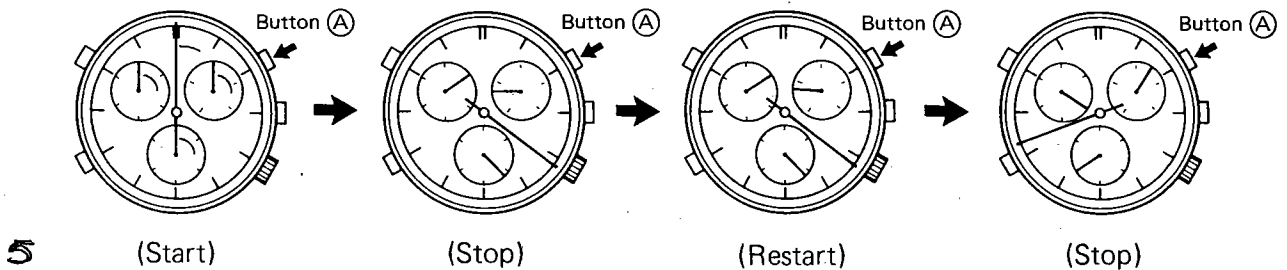

- The chronograph is changed over between Stop and Restart any number of times by repeatedly pressing the button (A) during measuring.

### 3-8. Using method of the chronograph when it is used as a counter

- The above-mentioned usage is available in the normal time display.

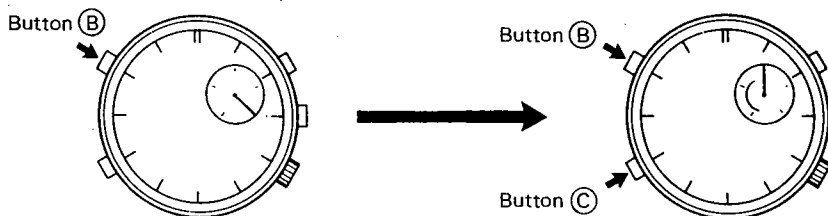

- (1) The CG 2/100 sec. hand advances one mark each time the button (B) is pressed, displaying 50 at its maximum.

- (2) After the counter is used, be sure to return the CG 2/100 sec. hand to the 0 position by pushing the button (B). (The CG 2/100 sec. hand returns to the 0 position even if the button (C) is pressed twice.)

### 3-9. ON/OFF of alarm (CAL. 3510/353※)

Pulling out the alarm switch activates alarm and pushing it in deactivates it.  
If you want to stop alarm from sounding, push in the alarm switch.

### 3-10. Display changeover between normal time and alarm time (CAL. 3510/353※)

Both normal time and alarm time are displayed using the same hour and minute hands.

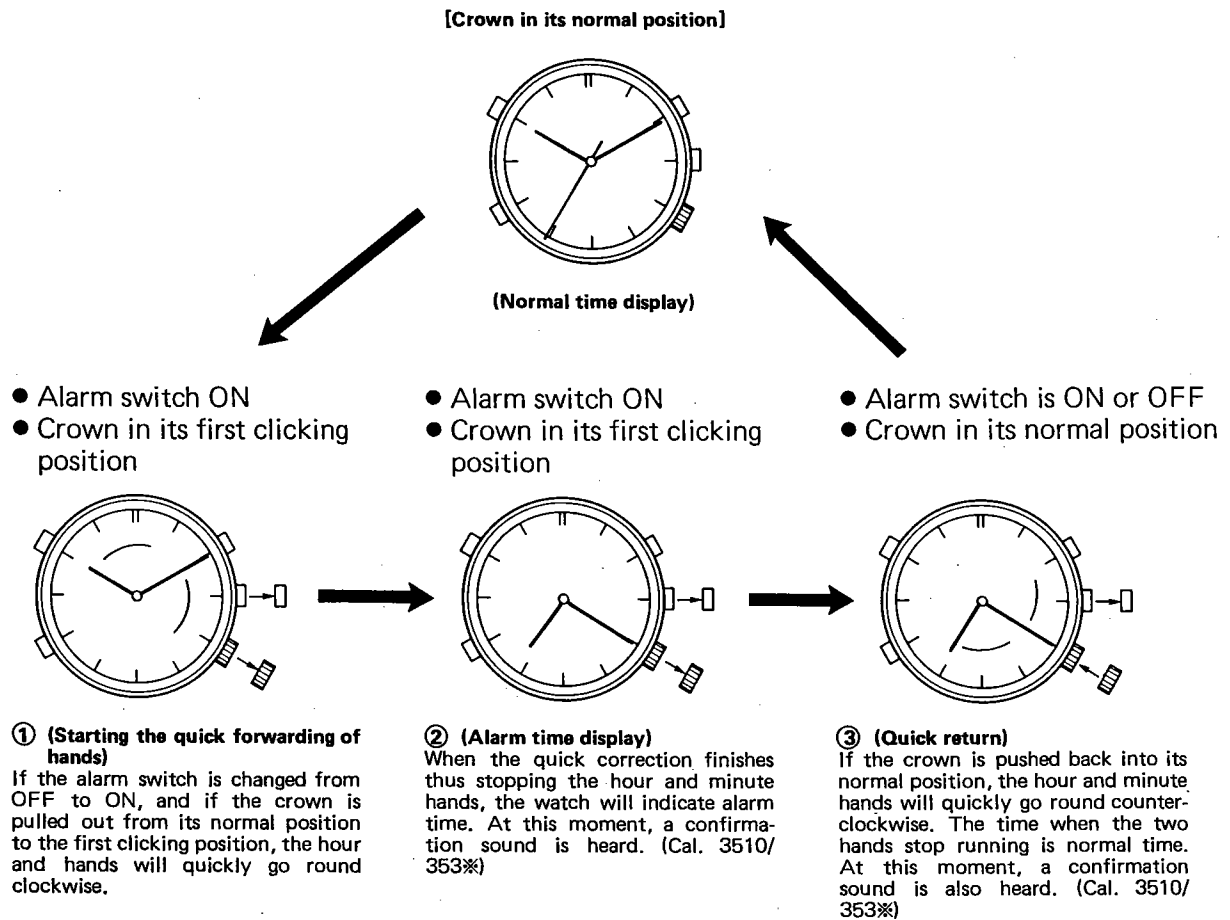

### 3-11. Setting of alarm time (CAL. 3510/353※)

- Alarm switch ON
- Crown in its first clicking position.

\* Time can be set on a 1-minute basis.

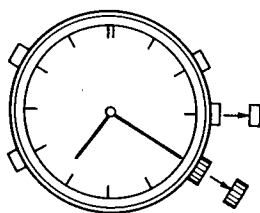

(Alarm time display)

- If the crown is turned clockwise, the hands will go round counterclockwise.
- If the crown is turned counterclockwise, the hands will go round clockwise.
- If the crown is turned quickly, the quick setting will be made.
- If you want to stop the quick setting, turn the crown slowly.
- If the crown is turned slowly, alarm time can be set on a 1-minute basis.
- When the alarm switch is ON, alarm sounds twice a day, each in the morning and afternoon. (Alarm sounds for 20 seconds for each.)

### 3-12. Using method of the chronograph when it is used as a timer

(which counts the residual time)

The above-mentioned usage is available in the normal time display.

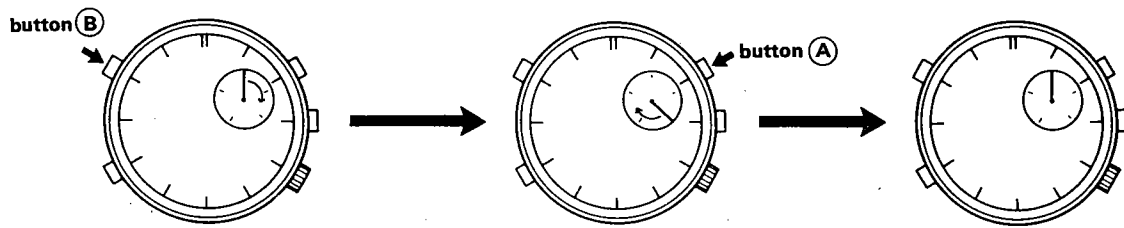

#### ① (Set time)

Set the CG 2/100 sec. hand to any time you like in the same manner as when the chronograph is used as a counter.

#### ② (Start timer)

If the button (A) is pressed, (a confirmation sound is heard ... Cal. 3510/353\*) to indicate that the timer has started. The timer runs on a 1-minute basis. If the residual time is less than 50 seconds, the timer runs on a 1-second basis.

#### ③ (Time is up)

(When time is up, a confirmation sound is heard for 10 seconds. ... Cal. 3510/353\*)

#### **Cancelling the timer halfway;**

- If the button (A) is pressed while the timer is operating, the timer stops at any time you like. (At this time, a confirmation sound is heard. .... CAL. 3510/353\*)
- If the timer is not used, be sure to return the CG 2/100 sec. hand to the 0 position referring to the operation of the counter described in the item No. 3-8.

### 3-13. Alarm monitor (CAL. 3510/353\*)

In any display modes, alarm serves as an alarm monitor, sounding for 5 seconds if the alarm switch is changed over in order of ON → OFF → ON in a second.

### 3-14. Power cell life indicator

If the power cell life nears end, the second hand changes its running mode from a 1-second basis to a 2-second basis, thus indicating the time when the power cell should be replaced.



## ■4. NOTES ON DISASSEMBLY AND ASSEMBLY OF MODULE

### 4-1. Mounting and removing the power cell

Pull the pointed end of the power cell holder in the direction of the arrow with a fine instrument such as tweezers, as illustrated to the right, while lightly pushing the upper surface of the power cell using fingers, and the power cell can be removed. (Be careful not to damage the power cell.)

Mount the power cell with the power cell holder pulled out in the direction of the arrow.

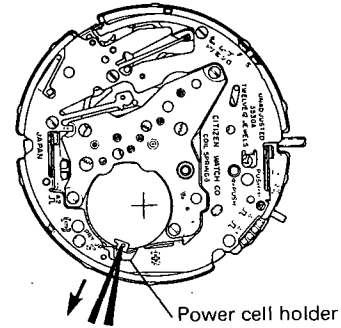

### 4-2. Mounting the mechanism

Mount the mechanism with a special care on the following:

- When mounting the yoke, be careful so that the yoke spring does not rest on the center wheel cock. (It should be in contact with the side surface of the center wheel cock.)
- Carefully handle the switch springs (I), (II) and (III) so that they won't change in shape.
- Mount the mechanism completely so that they won't come off.

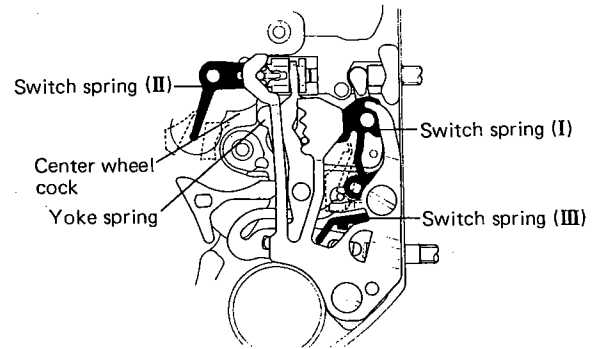

### 4-3. Mounting the train wheel

Mounting the third wheel and pinion, fourth wheel and pinion and the minute wheel and pinion.

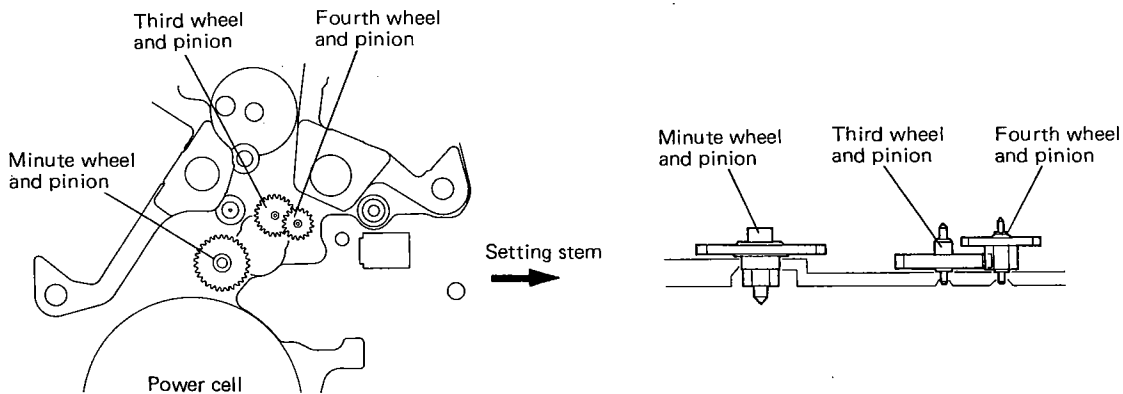

- Mounting the parts ranging from the second wheel to the intermediate second wheel.

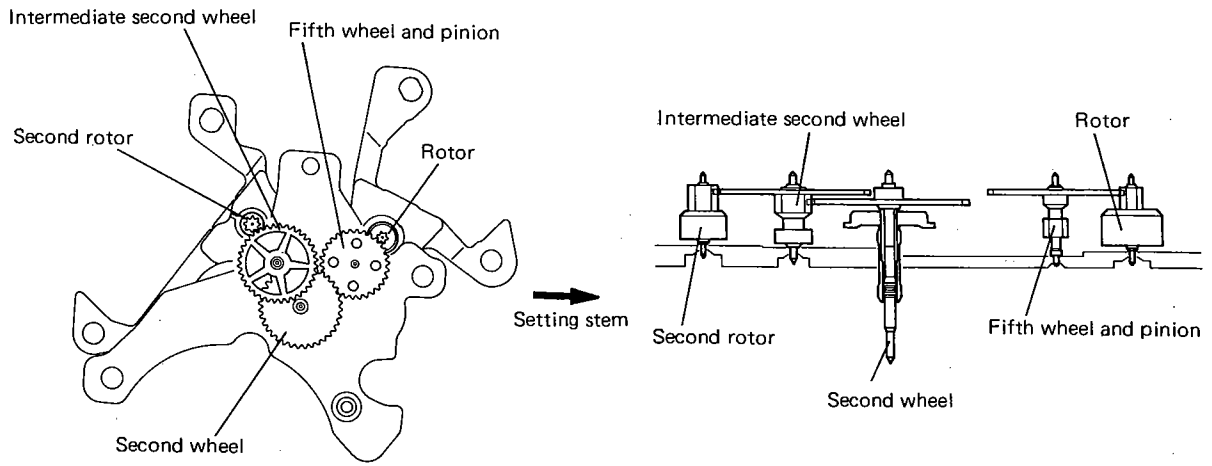

- Mounting the parts ranging from the second-recording wheel to the hour-recording wheel.

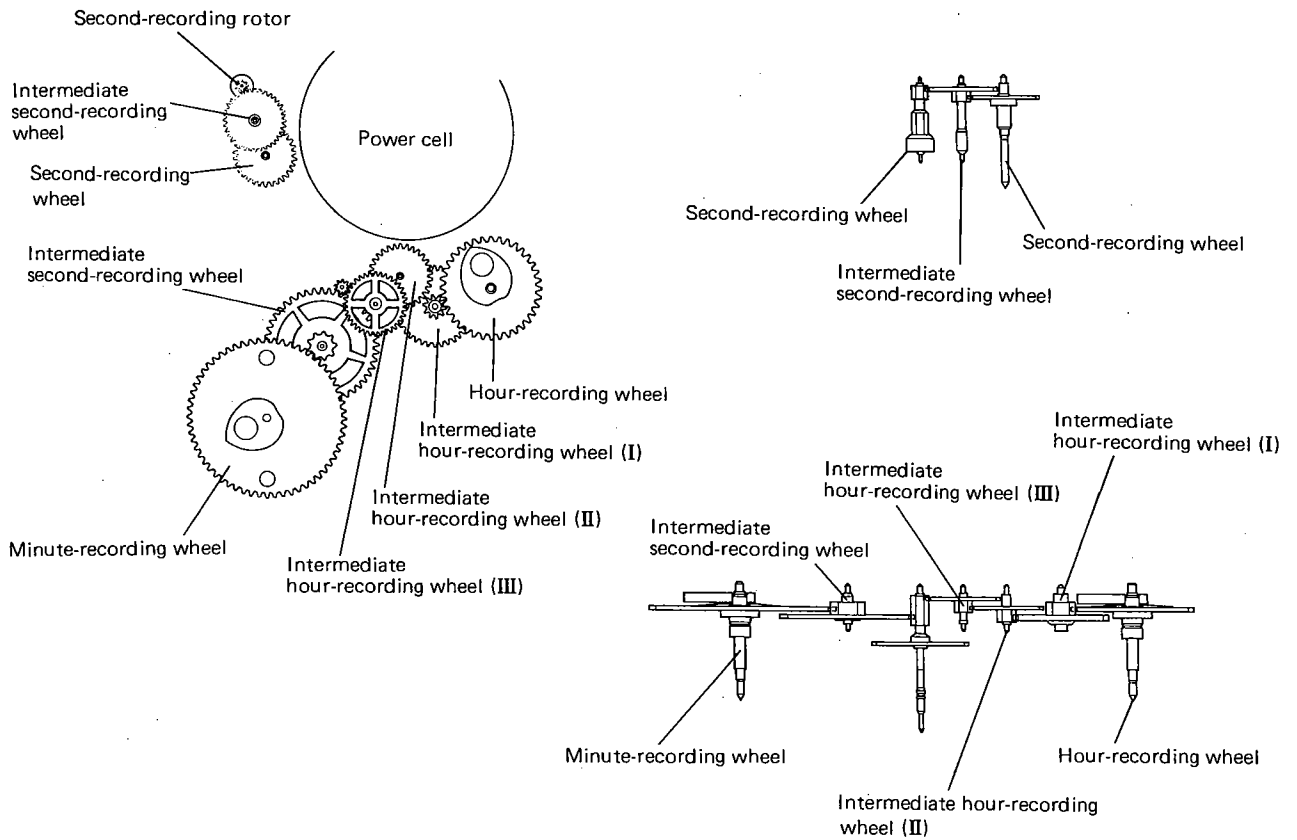

#### 4-4. Mounting the chronograph guard

When mounting the chronograph guard, pay attention to the following:

- 1) The pointed end of the spring for the chronograph guard, which is identified as A in the illustration, should mesh with the rupture inside the operating lever.
- 2) The pointed end of the spring for the chronograph guard, which is identified as B, should be placed in the groove of the lever for pillar wheel.
- 3) The pointed end of the spring for the chronograph guard, which is identified as C, should not rest on the pin of the fly-back connection lever.

If the above instructions are not observed, each button may operate improperly.

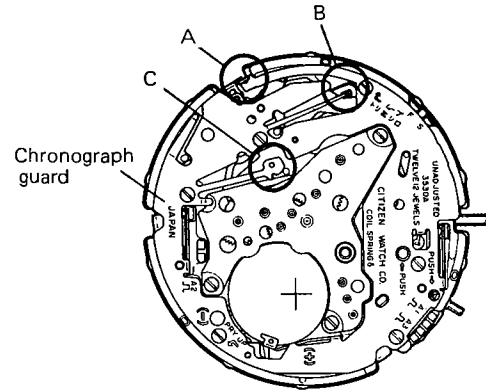

#### 4-5. Precautions for installing the moon's age plate (CAL. No. 3570)

After the moon's age plate is installed, if part A of the moon's age plate wheel lever is moved with tweezers etc. in the direction of the arrow, the tip of the moon's age plate wheel lever is moved aside. The tip of the moon's age plate wheel lever is engaged with the gear under the moon's age plate to rotate it.

Note: Do not move the moon's age plate wheel lever too strongly. (It causes damage to the lever.)

\* When removing the gib for the moon's age plate, take care not to let it spring out and be lost.

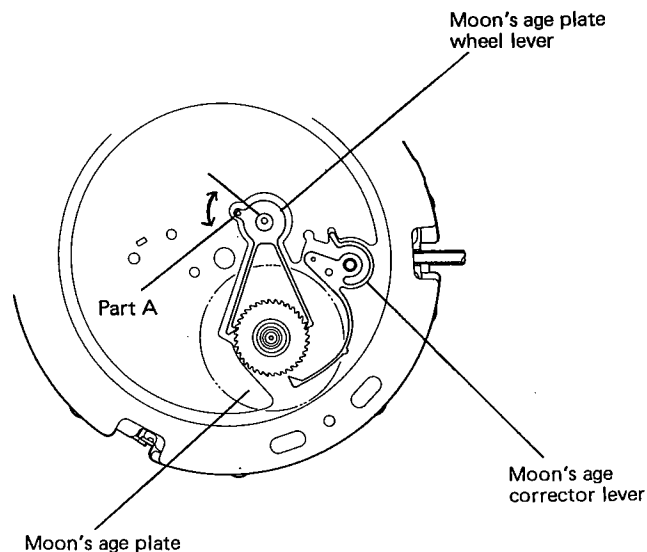

## ■5. HANDLING PROCEDURE OF APPEARANCE PARTS

- How to remove the setting stem and the switch setting stem

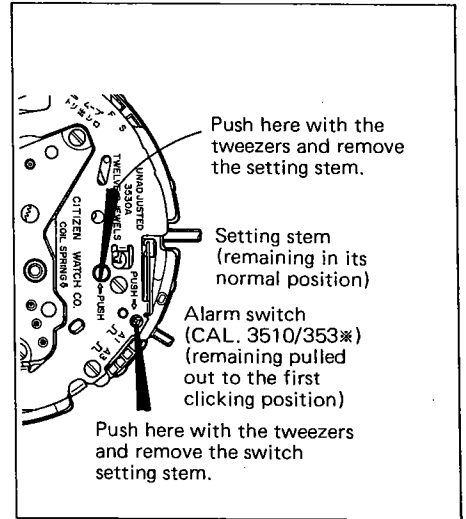
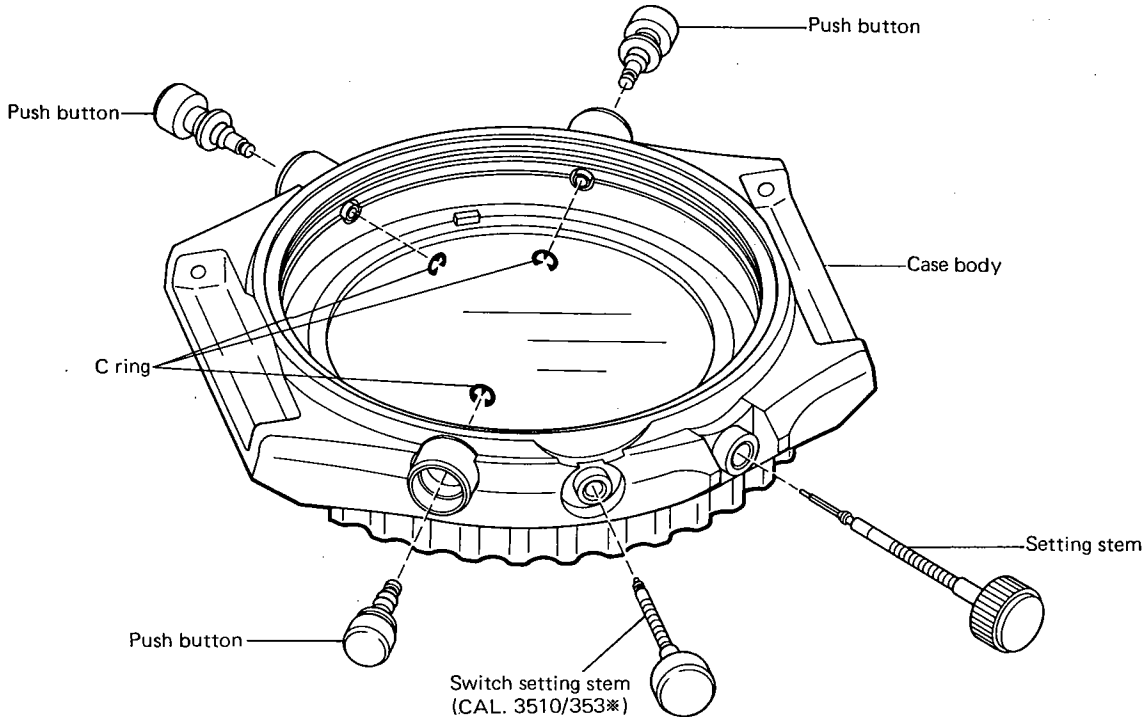
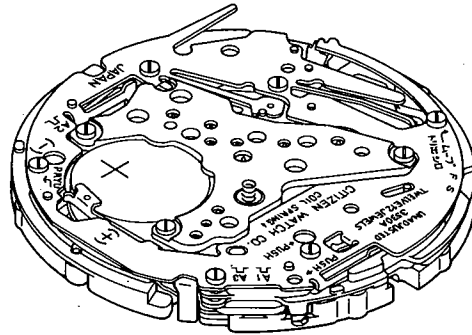
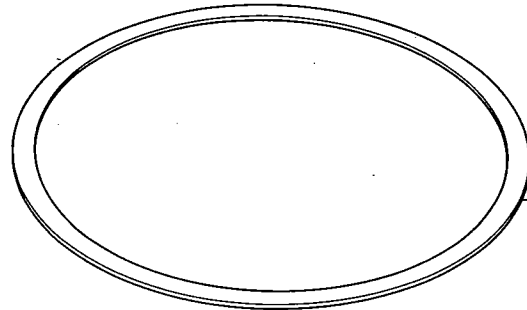
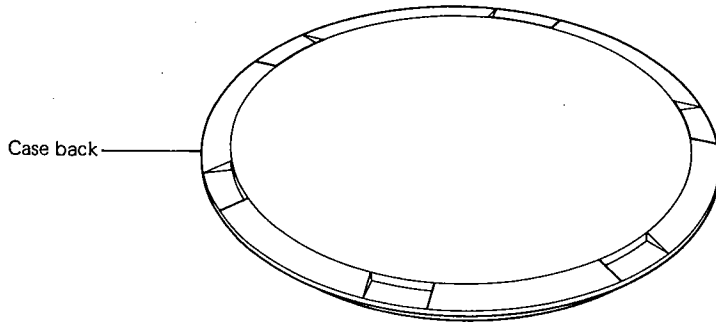

## 6. DISASSEMBLY AND ASSEMBLY OF MOVEMENT

Disassembling procedure : ① → ⑤⑧

Assembling procedure : ⑤⑧ → ①

Lubrication symbols

Ⓐ : A lube

∇ : V lube

Ⓕ : F lube

∞ : CH-1

### 1) Dial side

CAL. 353\*\*

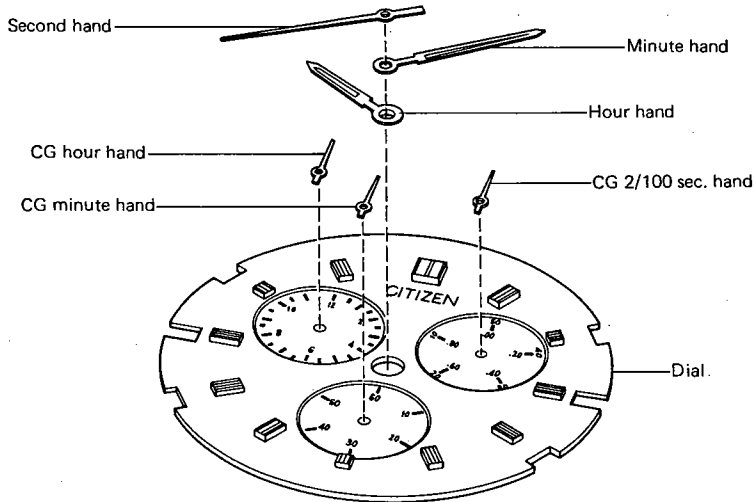

- Mounting each CG hand
- Mount each hand for the chronograph while normal time is displayed.

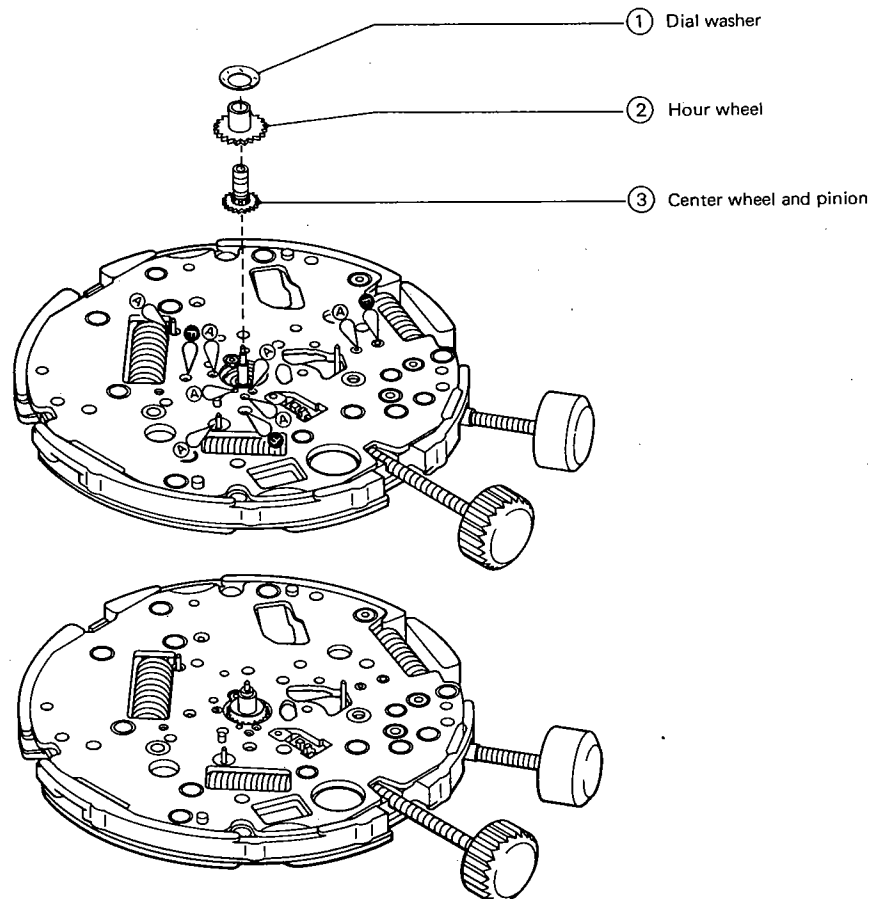

**CAL. 3510※, 3560※**

\* This is the development drawing of Cal. 3411※, which is almost the same as Cal. 351/356.

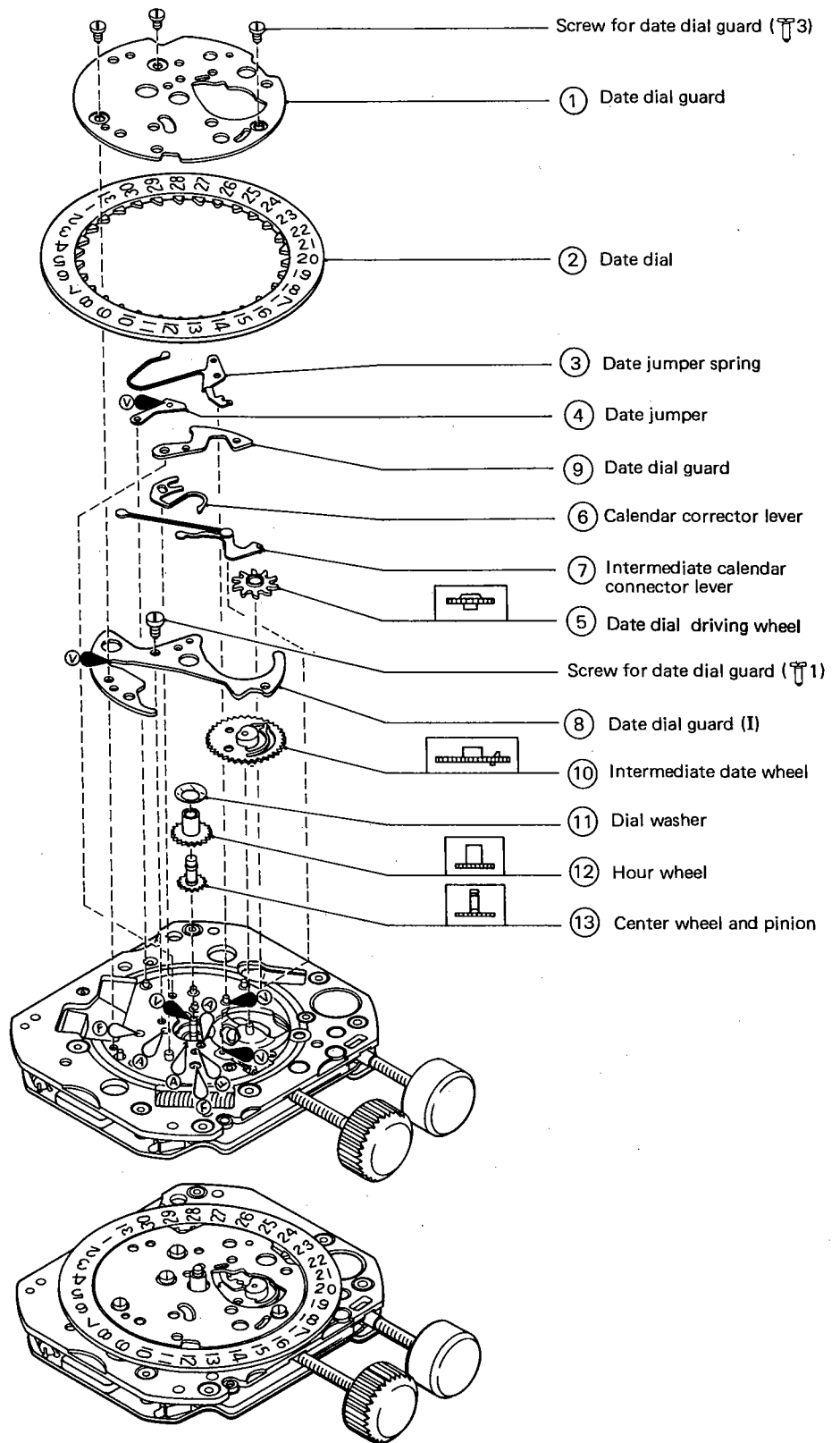

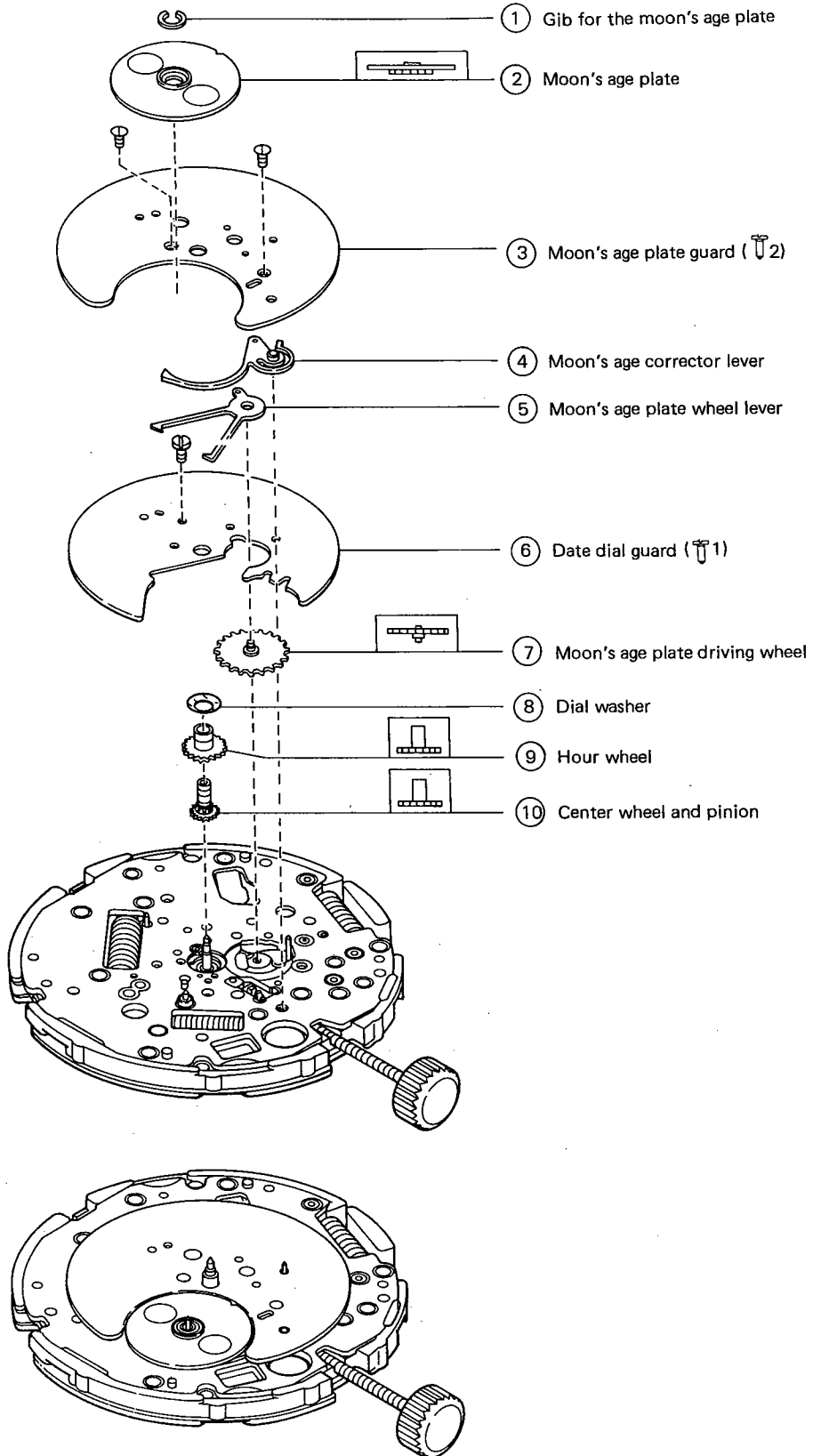

## 2) Power cell side

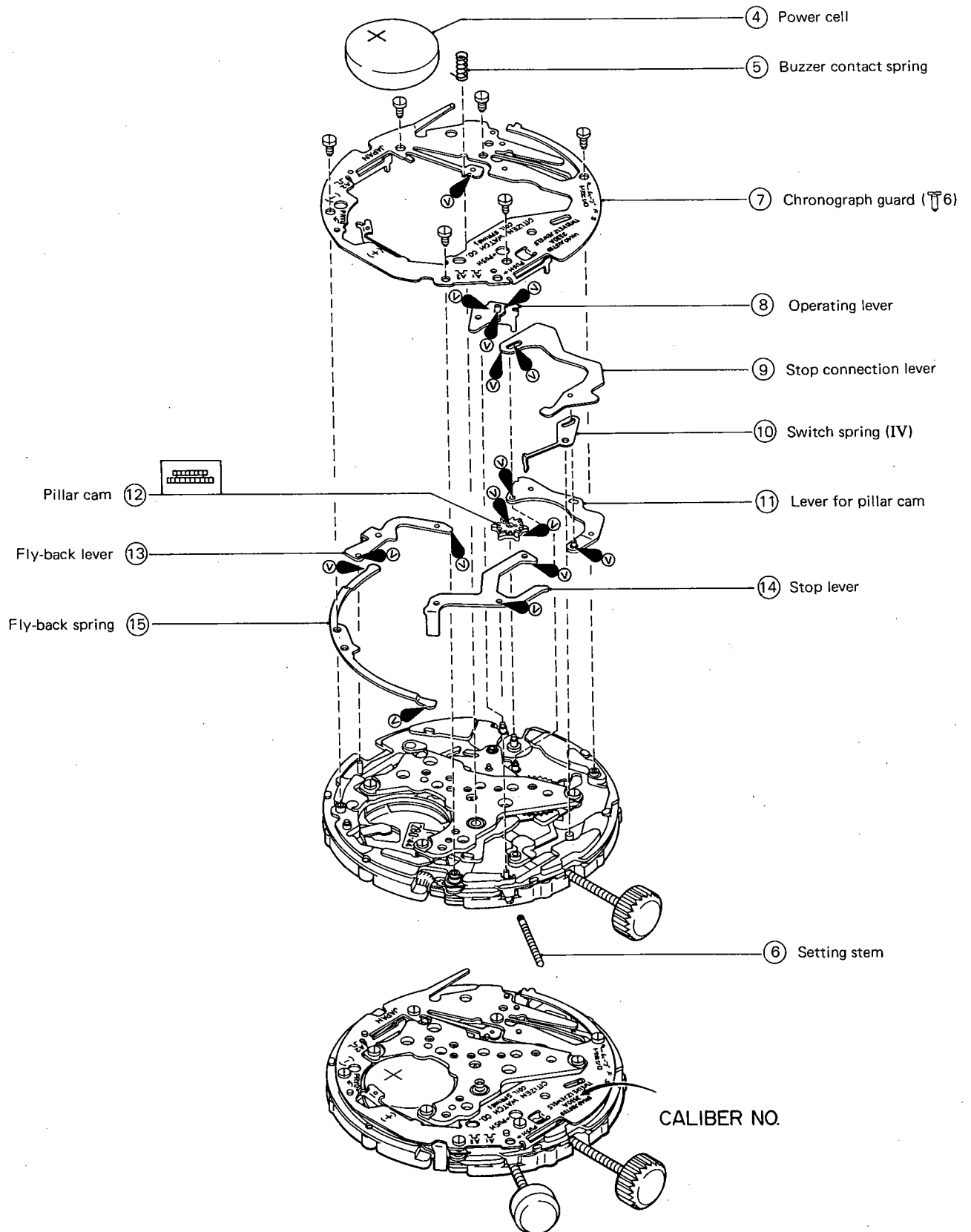



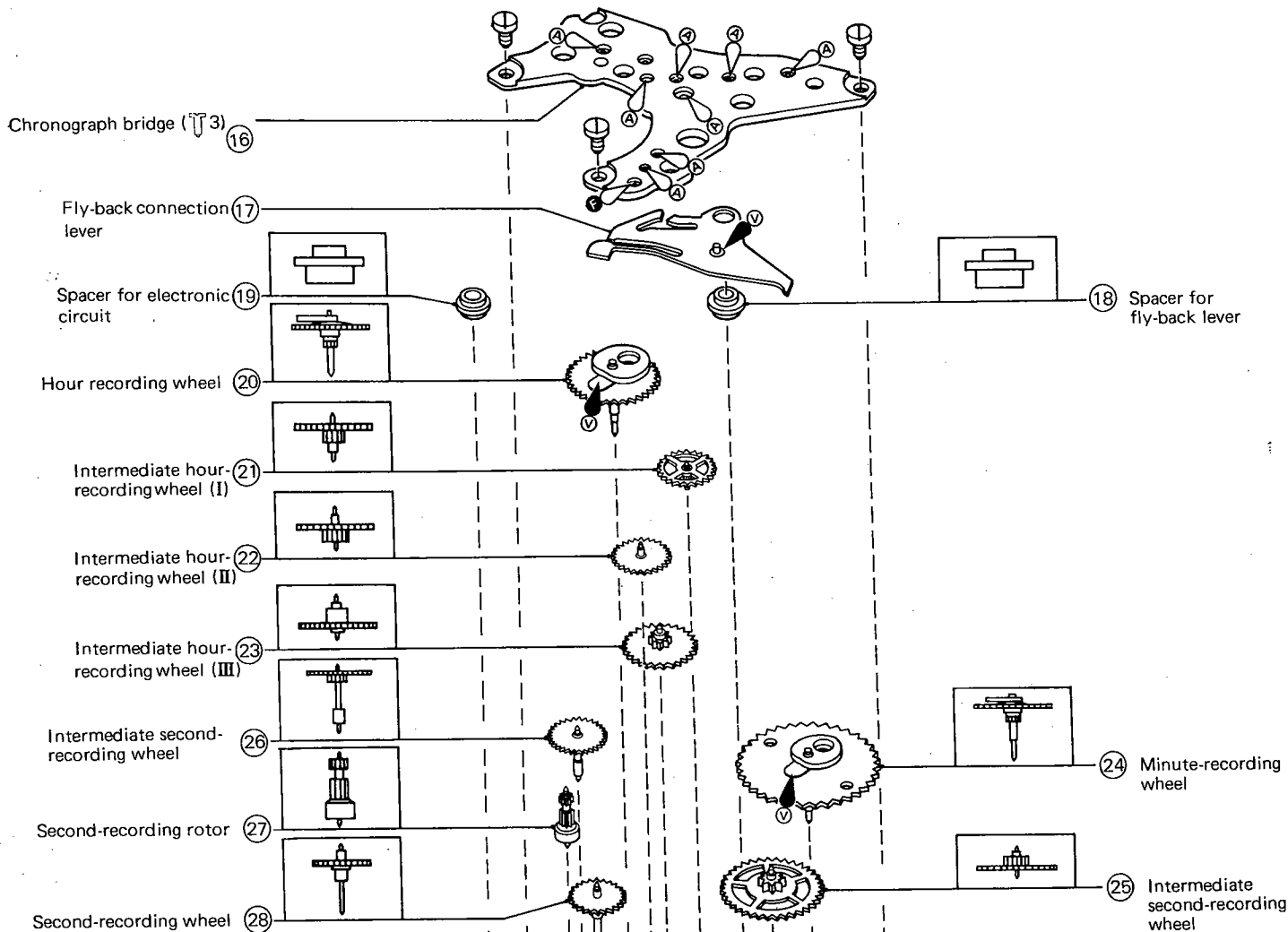

\* Apply a considerable amount of V-lube to where the under surface of the heart cam of the CG hour wheel/CG minute wheel and the ratchet spring move rubbing against each other.

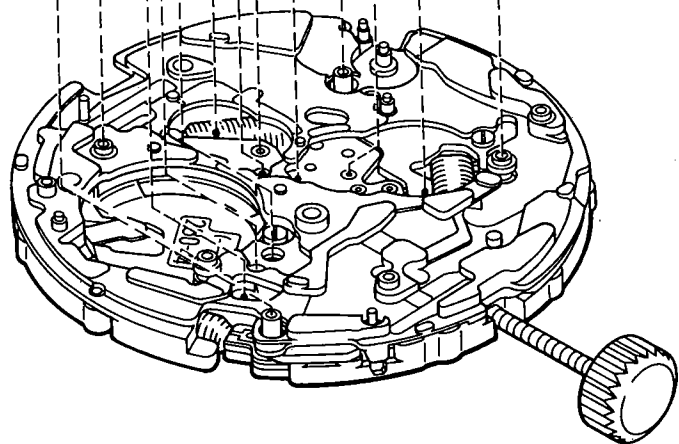

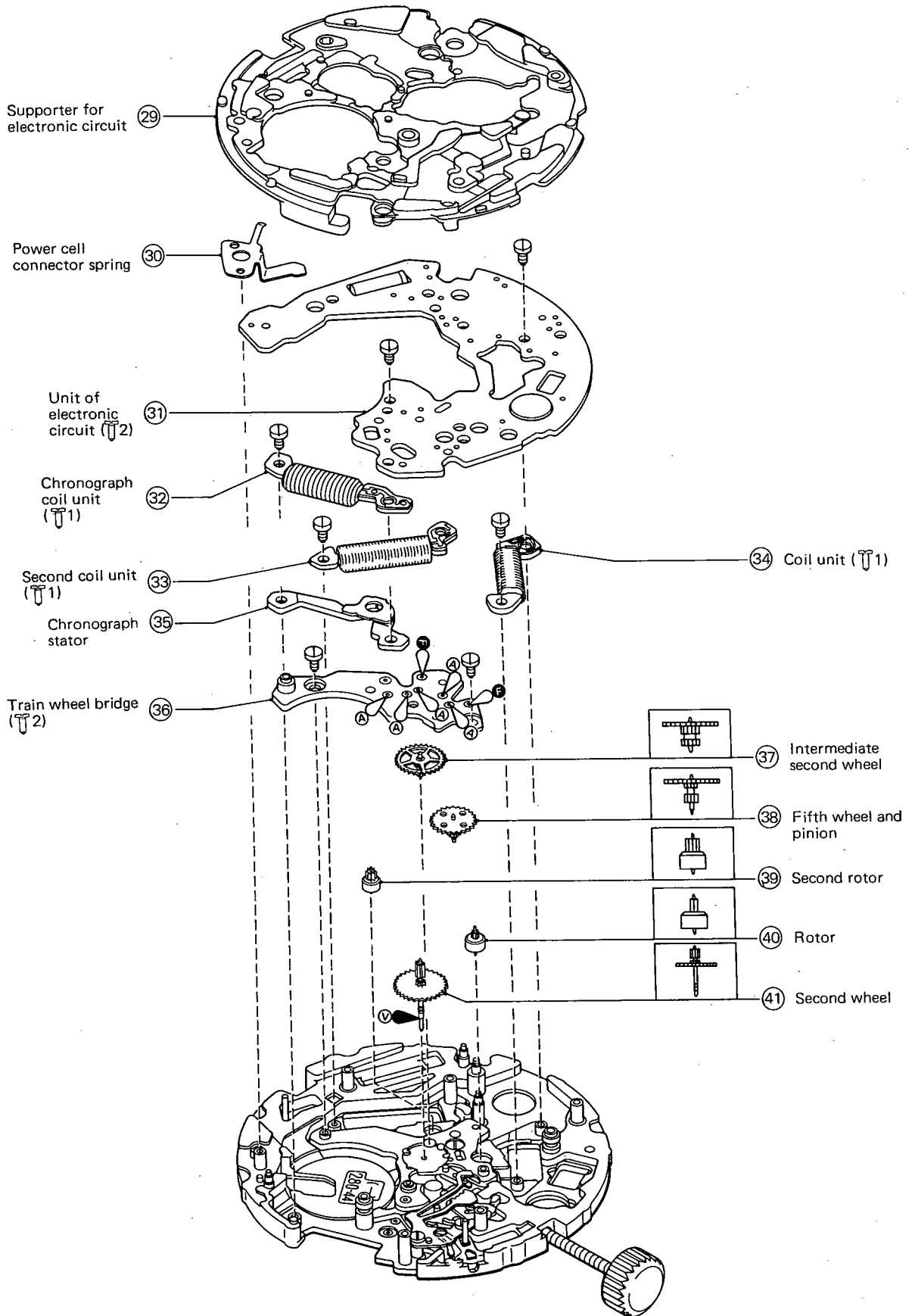

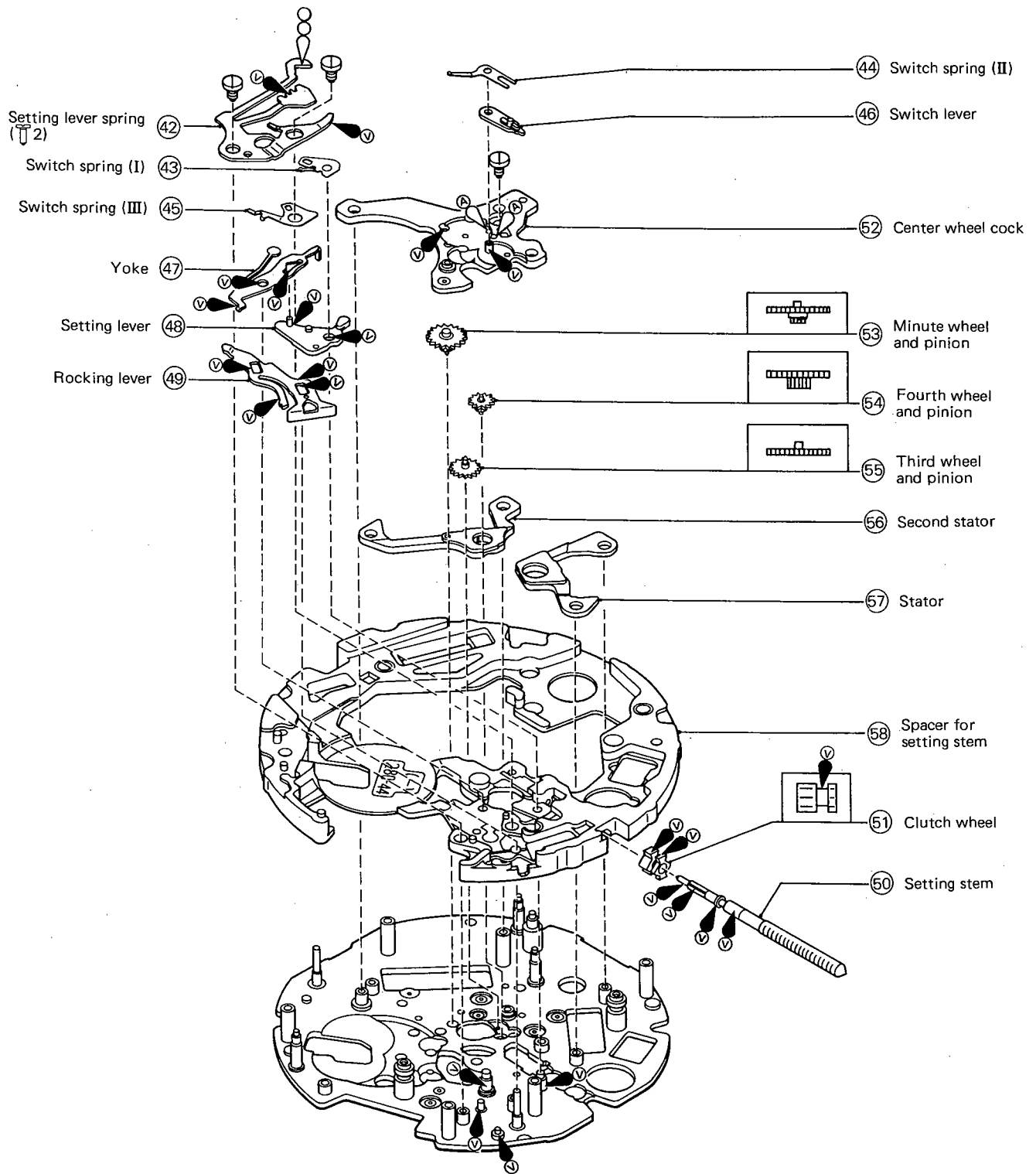

## ■7. CONCERNING SWITCH MECHANISM

### (1) Changeover of functions

(Normal time → Correction of alarm time → Correction of normal time)

As shown in the illustrations below, the pointed end of the switch spring (I) moves by operating the crown.

Patterns SR1 and SR2 on the back side of the electronic circuit are within the area where the pointed end of the spring moves. Depending on whether the pointed end of the switch spring makes contact with SR1 or SR2, functions are changed over one another. (See Table 1)

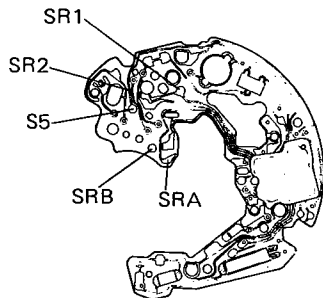
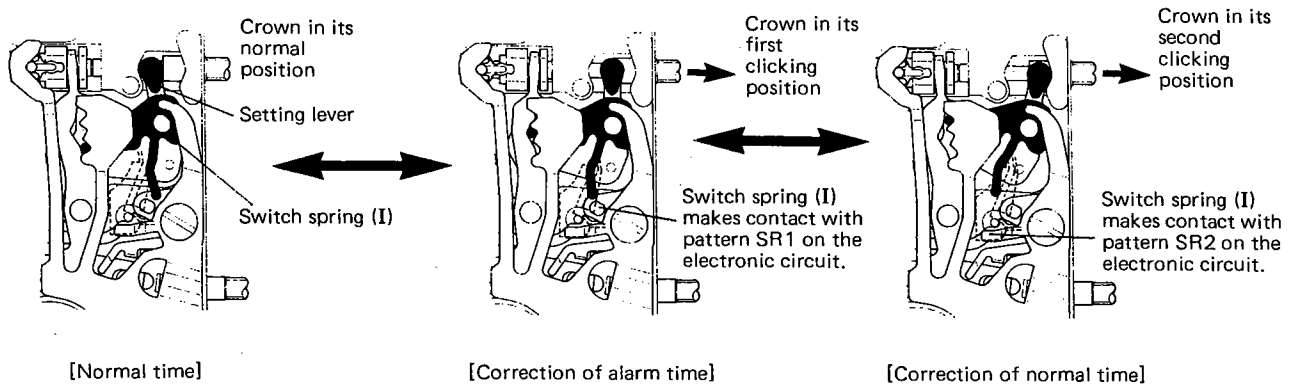

Position of crown	Switch spring (I)	Function
Normal position	Having no contact with the patterns	● Normal time
First clicking position	Having contact with pattern SR1	● Quick correction of calendar
		● Correction of alarm
Second clicking position	Having contact with pattern SR2	● Correction of normal time

(Table 1)

### (2) Time correction (Normal time/alarm time)

If the crown is turned clockwise or counterclockwise in correcting normal time or alarm time, the clutch wheel will rotate, thus causing the pointed end of the switch spring (II) to swing right or left with the aid of the switch lever with which the hour wheel contacts.

Patterns SRA and SRB on the back side of the electronic circuit are within the area where the pointed end of the switch spring (II) swings. Depending on whether the pointed end of the switch spring makes contact with SRA or SRB, the hands will turn clockwise or counterclockwise.

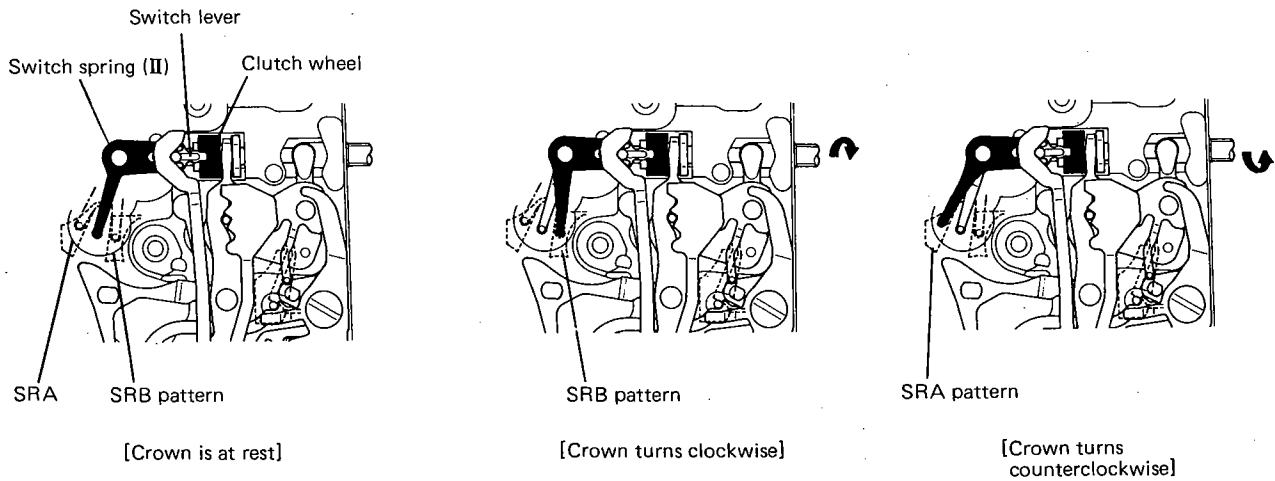

Depending on the state of contact between the switch spring (II) and pattern SRA/SRB, the following corrections are available.

- (a) Continuous correction (64Hz)
  - (b) Occasional correction (every pulse) . . .  
Normal time is corrected on a 20-second basis and alarm time is corrected on a 1-minute basis.
- (a) is used for rough correction and (b) is for fine correction.
- (a) and (b) are easily achieved by changing the turning speed of the crown.
- Turning the crown quickly . . . . . Continuous correction
  - Turning the crown slowly . . . . . Occasional correction

No matter how the crown is turned, clockwise or counterclockwise, these corrections are available.

Continuous quick forwarding of the hands (64Hz) will stop if the crown is turned slowly.

**(3) ON/OFF of the alarm switch (Cal. 3510/353※)**

Alarm is turned ON or OFF by pulling the alarm switch out to the first clicking position or pushing it back to its normal position. That is to say, by operating the alarm switch, the pointed end of the switch spring (III) moves up and down with the aid of the rocking bar.

When the pointed end of the switch spring (III) goes up, it makes contact with pattern S1 on the back side of the electronic circuit, thus turning the alarm OFF.

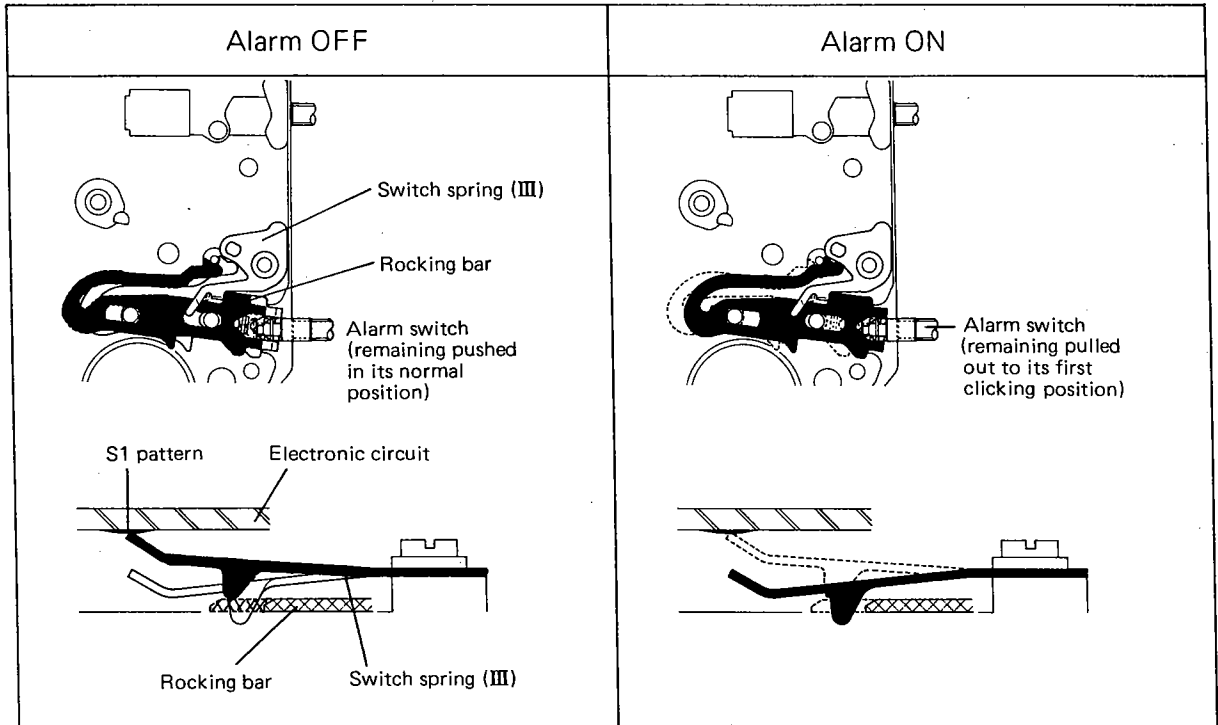

\*The above illustrations show the other caliber and thus the positions of Cal. 3530's parts are different from the illustrations. Use these illustrations just to learn the switching method.

**(4) Display changoover between normal time and chronograph**

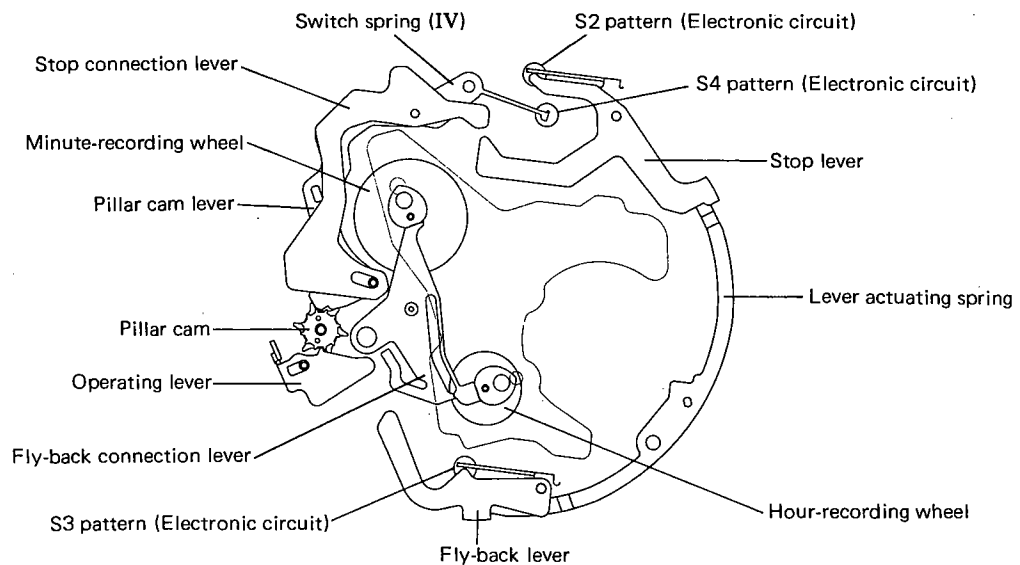

(Position of each lever in the normal time display)

- (a) Change from the normal time display to the chronograph display

Pressing the button (C) causes the following, which are described in the illustration to the right.

- 1) The pillar cam rotates in the direction of arrow (1) with the aid of the operating lever.
- 2) The pillar cam lever moves in the direction of arrow (2) with the aid of the claws of the pillar cam.
- 3) In keeping with the movement of the pillar cam lever, the switch spring (IV) moves in the direction of arrow (3). At this time, the pointed end of the switch spring (IV) makes contact with pattern S4, and thus the normal time display will be electrically replaced by the chronograph display. Simultaneously, the second hand quickly advances to the 0 position.

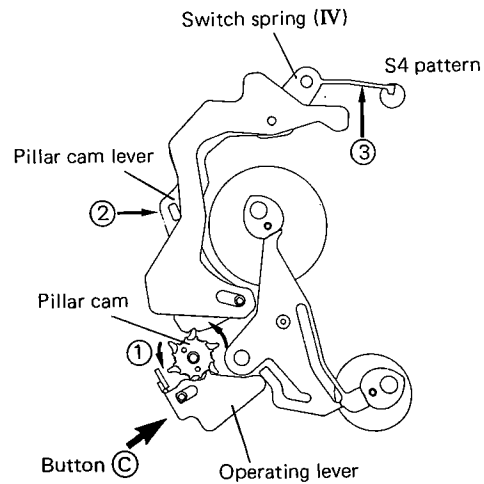

- (b) Change from the chronograph display to the normal time display

Pressing the button (C) causes the reverse phenomena to the above item (a), and thus the chronograph display will be replaced by the normal time display

If the chronograph is used, the fly-back connection lever which has been separated from each heart cam of the hour-recording wheel and the minute-recording wheel, will also move in the direction of the arrow.

Simultaneously, each chronograph hand of the hour, minute and 2/100 sec. will return to the 0 position and the second hand will change its role into the normal time indicator.

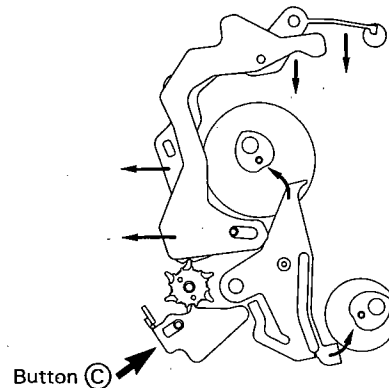

## (5) Start/stop of the chronograph

(The chronograph should start or stop its performance in the chronograph display.)

### (a) Start

Pressing the button (A) causes the following, which are described in the illustration to the right.

- 1) The stop lever moves in the direction of arrow ①. At this moment, the stop connection lever moves in the direction of arrow ②. As a result, the fly-back connection lever moves in the direction of arrow ③, separating from both the hour-recording wheel and the minute-recording wheel.
- 2) Meanwhile, the pointed end of the spring of the chronograph guard makes contact with pattern S2 with the aid of the stop lever, which switches the chronograph ON thus starting operation.

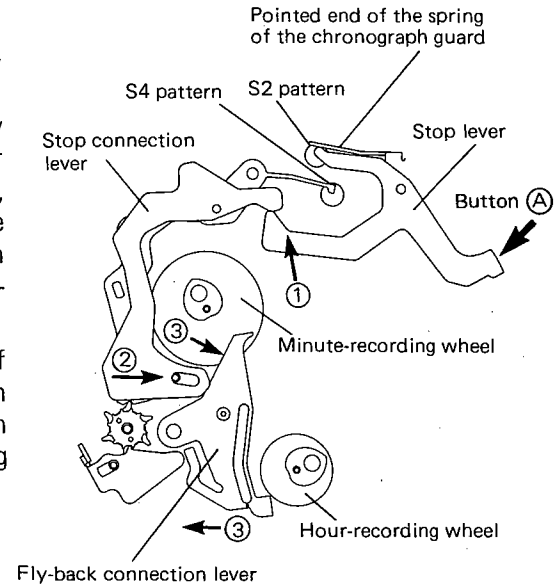

### (b) Stop

Pressing the button (A) during being ready to start causes the following:

- 1) The spring of the chronograph guard makes contact with pattern S2 with the aid of the stop lever. As a result, the chronograph is switched OFF, thus stopping its operation. However, other levers remain ready to start.

## (6) Start/stop of the timer

The timer starts or stops operation depending on whether the pointed end of the spring of the chronograph guard makes contact with pattern S2 with the aid of the stop lever if the button (A) is operated under the condition that the switch spring (IV) has no contact with pattern S4 (under the condition of the normal time display).

## (7) Setting/resetting of the chronograph (timer/counter)

Pressing the button (B) when the chronograph stops causes the following:

- 1) The fly-back lever moves in the direction of the arrow. At the same time, the fly-back connection lever makes contact with each heart cam of the hour-recording wheel and minute-recording wheel.
- 2) Meanwhile, the spring of the chronograph guard makes contact with pattern S3 with the aid of the fly-back lever, thus enabling the chronograph to be set or reset in the measuring display. (The timer and counter have the same setting and resetting procedures as the chronograph.)

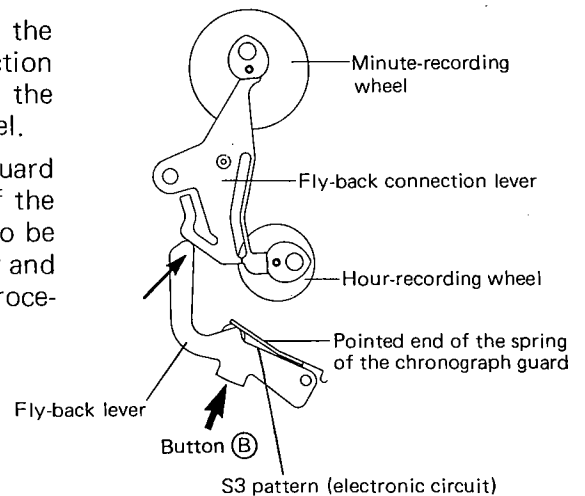



**(8) Hour/Minute-recording wheel**

1) The chronograph at rest

When the fly-back connection lever makes continuous contact with the heart cam, the ratchet spring, which is located under the heart cam, slips on the under surface of the heart cam. Therefore, the heart cam stops operation, thus causing the chronograph to stop operation.

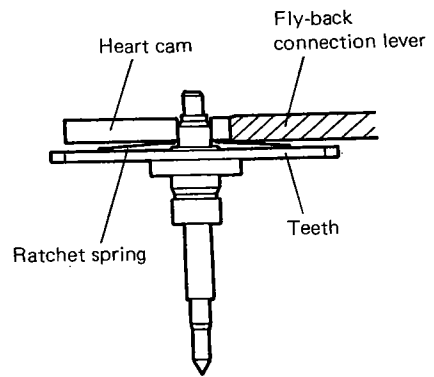

(Hour-recording wheel/Minute-recording wheel)

2) The chronograph at start

While the fly-back connection lever is separated from the heart cam, the clutch spring, which is located under the heart cam, supports the under surface of the heart cam. As a result, the shaft of the hour (minute)-recording wheel rotates thus causing the chronograph to start operation.

# FLOW CHART OF TROUBLESHOOTING AND ADJUSTMENT

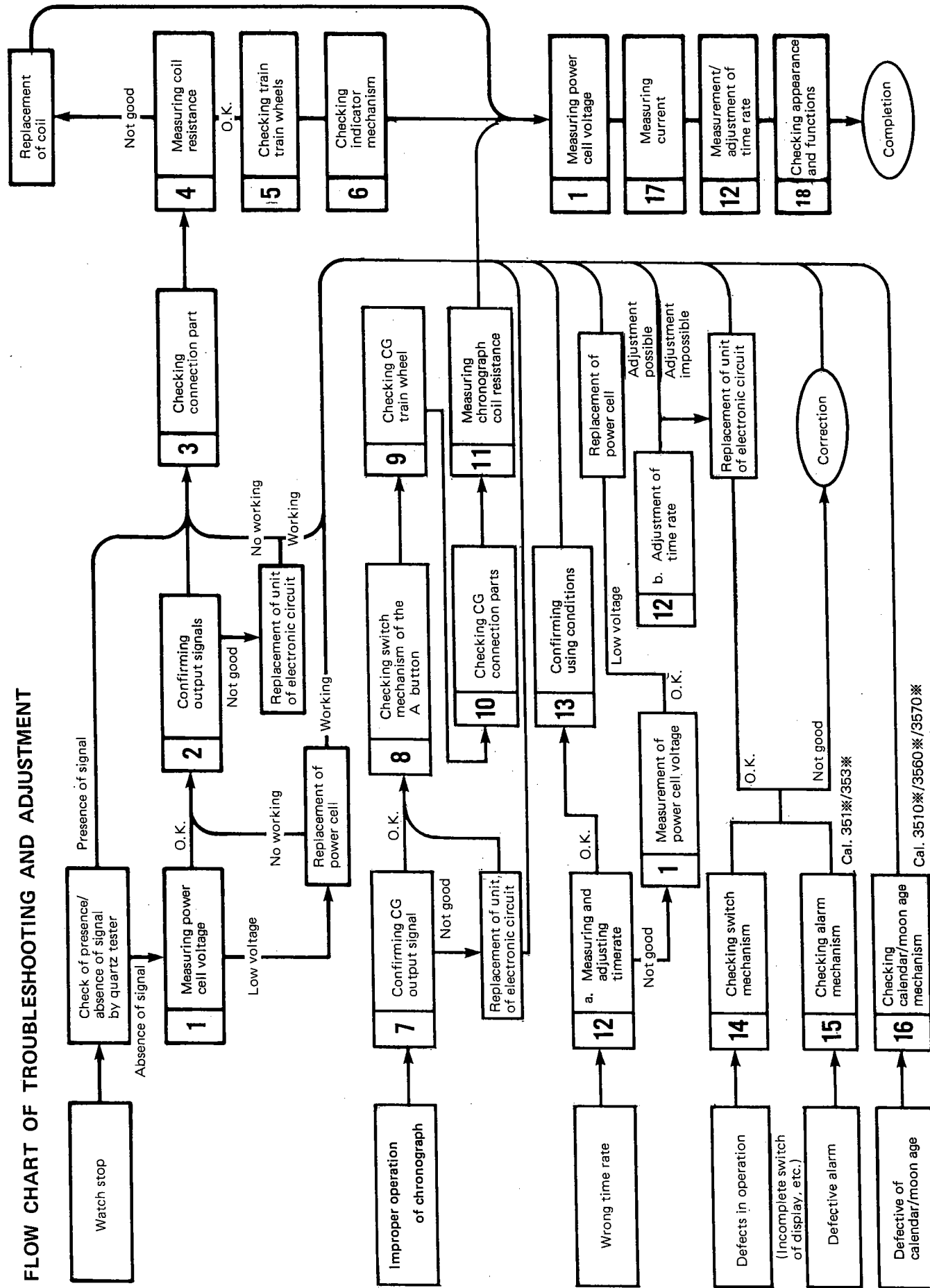

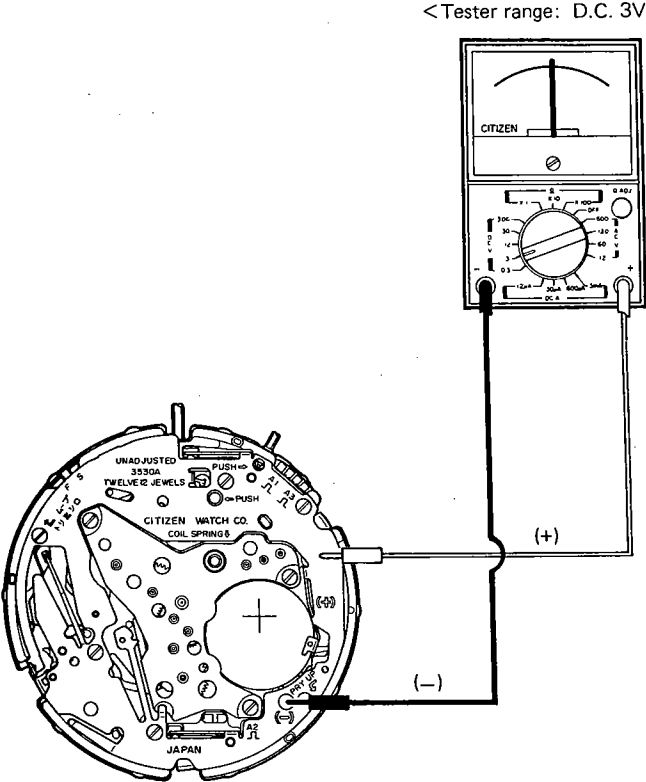
Check points	How to check	Results & treatment
<p><b>1</b> Measuring power cell voltage</p>	<p style="text-align: center;">&lt; Tester range: D.C. 3V &gt;</p> 	<p><b>Over 1.5V</b> → Nondefective</p> <p><b>Under 1.5V</b> → Replace the power cell.</p> <p>If the screws for fixing the electronic circuit are loose, voltage may not fully be applied to the circuit.</p>
<p><b>2</b> Confirming output signals</p>	<p>This watch has three types of output signals as below;</p> <ul style="list-style-type: none"> <li>● Step motor for hour and minute timing (A1<math>\mu</math>L output signal)</li> <li>● Step motor for second timing (A2<math>\mu</math>L output signal)</li> <li>● Step motor for CG's 2/100 sec. counting (A3<math>\mu</math>L output signal)</li> </ul> <p>If the watch runs down, confirm A1 and A2 output signals of the above three.</p> <p>* Make sure that the crown is in its normal position.</p> <p>Confirm the output signals with the normal time display shown. It does not matter whichever polarity the tester lead pin has.</p> <p>1) Confirming A2 output signal:</p> <p>The A2 output signal is used for timing seconds. When the tester lead pin is put on the pattern of the A2 output signal as shown in Fig. 2, the tester pointer swings back and forth once every second.</p> <p>2) Confirming A1 output signal:</p> <p>The A1 output signal is used for timing hours and minutes. When the tester lead pin is put on the pattern of the A1 output signal as shown in Fig. 2, the tester pointer swings back and forth once every 20 seconds.</p>	

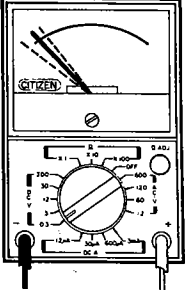
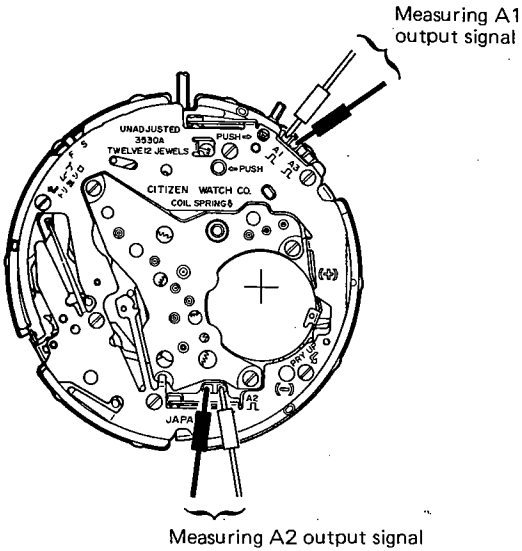
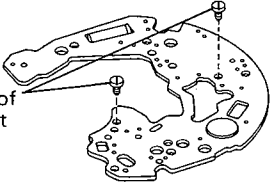
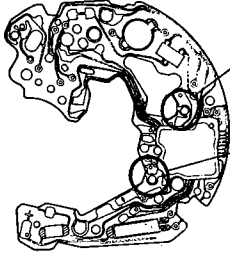
Check points	How to check	Results & treatment
	<p data-bbox="943 216 1187 237">&lt;Tester range: D.C. 3V&gt;</p>   <p data-bbox="954 659 1084 701">Measuring A1 output signal</p> <p data-bbox="732 1178 987 1199">Measuring A2 output signal</p>	<ul style="list-style-type: none"> <li>● A2 output signal           <ul style="list-style-type: none"> <li>The tester pointer swings (every second).</li> <li>→ Nondefective</li> </ul> </li> <li>The tester pointer does not swing.           <ul style="list-style-type: none"> <li>→ Replace the electronic circuit.</li> </ul> </li> <li>● A1 output signal           <ul style="list-style-type: none"> <li>The tester pointer swings (every 20 seconds).</li> <li>→ Nondefective</li> </ul> </li> <li>The tester pointer does not swing.           <ul style="list-style-type: none"> <li>→ Replace the electronic circuit.</li> </ul> </li> </ul>
<p data-bbox="237 1262 261 1283"><b>3</b></p> <p data-bbox="280 1262 402 1346">Checking connection parts</p>	<ol style="list-style-type: none"> <li data-bbox="488 1262 1187 1339">1) If the screws for unit of electronic circuit are loose, output signals may not be transmitted from the electronic circuit to the coil.</li> <li data-bbox="488 1367 1187 1444">2) If dust or dirt is found where the power cell connector spring contacts with the electronic circuit, a bad transmission of signals will result.</li> <li data-bbox="488 1472 1187 1549">3) If dust or dirt is found on the coil terminal of the coil unit/ second coil unit or the patterns of the output signals, a bad transmission of signals will result.</li> </ol>  <p data-bbox="350 1703 516 1745">Screws for unit of electronic circuit</p>  <p data-bbox="1068 1675 1365 1696">Pattern of the A1 output signal</p> <p data-bbox="1068 1766 1365 1787">Pattern of the A2 output signal</p>	<ol style="list-style-type: none"> <li data-bbox="1230 1283 1442 1346">1. Loosened screws → Tighten them.</li> <li data-bbox="1230 1373 1409 1436">2. Dust or dirt → Remove it.</li> <li data-bbox="1230 1463 1409 1526">3. Dust or dirt → Remove it.</li> </ol>

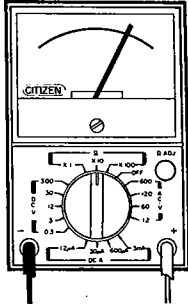
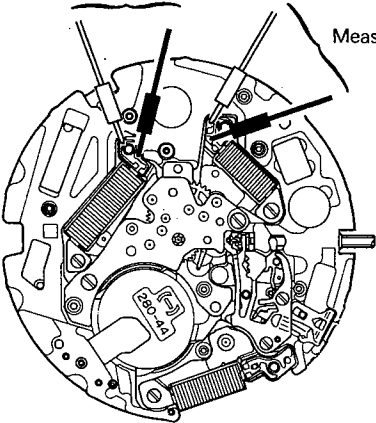
Check points	How to check	Results & treatment
<p><b>4</b> Measuring coil resistance</p>	<p>If the watch runs down, measure the following:</p> <ol style="list-style-type: none"> <li>1) Coil unit (for hour and minute timing)</li> <li>2) Second coil unit (for second timing)</li> </ol> <p>* It does not matter whichever polarity the tester lead pin has.</p> <div style="text-align: center;"> <p>&lt;Tester range: x 10Ω&gt;</p>  </div> <div style="text-align: center;">  <p>Measuring the second coil unit</p> <p>Measuring the coil unit</p> </div>	<ol style="list-style-type: none"> <li>1) Measuring the coil unit: <ul style="list-style-type: none"> <li>● 0.8kΩ ~ 1.3kΩ → Nondefective</li> <li>● Beyond the above range → Replace the coil unit.</li> </ul> </li> <li>2) Measuring the second coil unit <ul style="list-style-type: none"> <li>● 1.7kΩ ~ 2.1kΩ → Nondefective</li> <li>● Beyond the above range → Replace the second coil unit</li> </ul> </li> </ol>
<p><b>5</b> Checking train wheel</p>	<p>If the watch runs down, check the following 1) and 2) in terms of the items described further below;</p> <ol style="list-style-type: none"> <li>1) Minute wheel and pinion, third wheel and pinion and fourth wheel and pinion (See Page 11).</li> <li>2) Parts ranging from the second wheel to the intermediate second wheel (See Page 11).</li> </ol> <ul style="list-style-type: none"> <li>● Whether the transmission goes smoothly with each gear with an appropriate clearance and with no backlash;</li> <li>● Whether dust or foreign matter gets in the gears; <p>A special check is necessary to confirm that no cuttings adhere to the rotor.</p> </li> <li>● Whether the gears are lubricated in a good condition; <p>Check the following;</p> <p>If the gears are fully lubricated with no oil shortage;</p> <p>If they have become dirty;</p> <p>If oil fails to penetrate them;</p> <p>If they are excessively lubricated.</p> </li> <li>● Whether each hole jewel has no crack or slant.</li> </ul>	<ul style="list-style-type: none"> <li>● Backlash → Replace the parts.</li> <li>● Improper clearance → Adjust clearance.</li> <li>● Dust or foreign matter → Remove it.</li> <li>● Dirt → Wash away.</li> </ul>

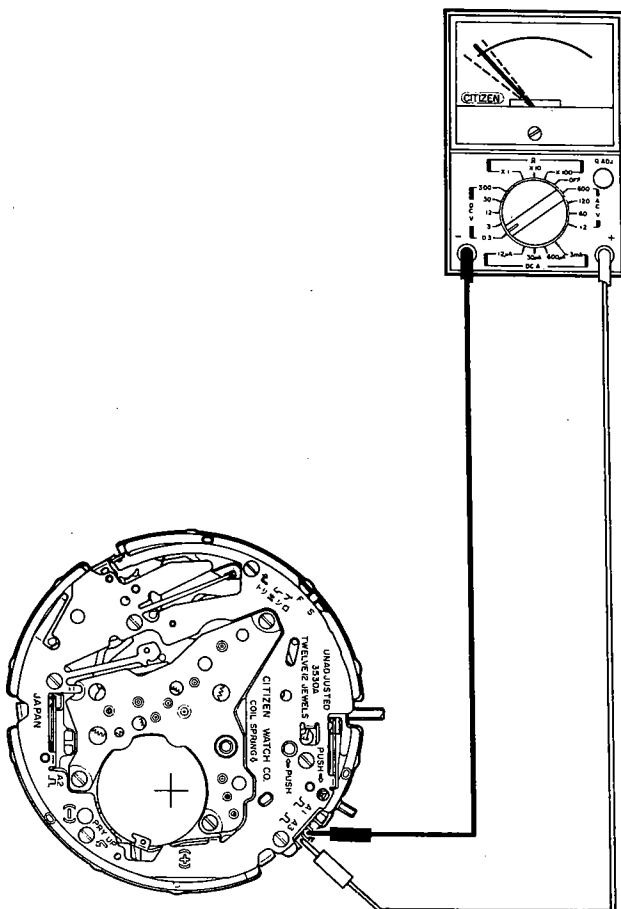
Check points	How to check	Results & treatment
<p><b>6</b> Checking indicator mechanism</p>	<ul style="list-style-type: none"> <li>● Make a check on the hour wheel, minute wheel and pinion and the center wheel and pinion.</li> </ul> <p>Special attention is necessary to see whether the third wheel and pinion and the center wheel and pinion mesh with each other.</p>	
<p><b>7</b> Confirming CG output signal</p>	<p>Confirm the output signal (A3Л) which drives the step motor for CG 2/100 sec. timing.</p> <ul style="list-style-type: none"> <li>*1 It does not matter whichever polarity the tester lead pin has.</li> <li>*2 Measure the A3 output signal after the chronograph starts operation.</li> </ul> <p>Measure it within 3 minutes after the start because the output signal stops 3 minutes after the start.</p> <p style="text-align: center;">&lt;Tester range: D.C. 0.3V&gt;</p> 	<p>A3 output signal</p> <ul style="list-style-type: none"> <li>● The tester pointer swings little by little around 0V.</li> <li>→ Nondefective.</li> <li>● The tester pointer does not swing.</li> <li>→ Replace the electronic circuit.</li> </ul>

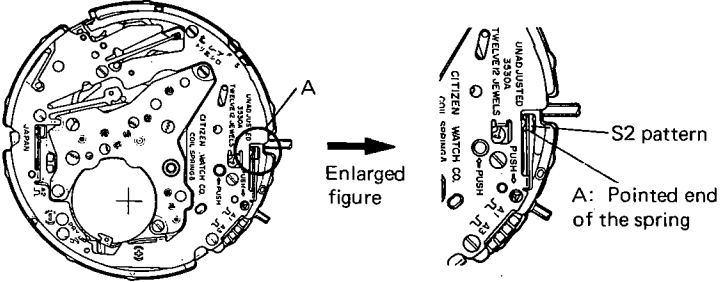
Check points	How to check	Results & treatment
<p>8 Checking switch mechanism of the button (A)</p>	<p>1) Confirm that the button (A) makes a smooth operation and also confirm that it has not been deformed.</p> <p>2) Confirm that there is no dust or dirt on the pointed end of the spring, which is identified as A in the figure and on pattern S2 on the electronic circuit.</p>  <p>3) Confirm that the fly-back spring, stop lever, stop connection lever, fly-back connection lever and lever for pillar wheel have all been properly mounted.</p>	<p>1) The button does not operate smoothly.</p> <ul style="list-style-type: none"> <li>● Dust or dirt → Remove it.</li> <li>● Apply oil again to the packing of the push button.</li> <li>● Deformed part → Replace the part.</li> </ul> <p>2) Dust or dirt → Remove it.</p> <p>3) Bad mounting → Mount again.</p>
<p>9 Checking CG train wheel</p>	<p>Check the parts ranging from the second-recording wheel to the hour-recording wheel (see Page 11) in terms of the following items:</p> <ul style="list-style-type: none"> <li>● Whether the transmission goes smoothly with each gear with appropriate clearance and with no backlash;</li> <li>● Whether dust or foreign matter gets in the gears; A special check is necessary to see that no cuttings have adhered to the rotor.</li> <li>● Whether the gears are lubricated in a good condition; Check the following; If they are fully lubricated with no supply shortage of oil; If they have become dirty; If oil fails to penetrate; If they are excessively lubricated.</li> <li>● Whether each hole jewel has no crack or slant.</li> </ul>	<ul style="list-style-type: none"> <li>● Backlash → Replace the bad parts.</li> <li>● Improper clearance → Adjust clearance.</li> <li>● Dust or foreign matter → Remove it.</li> <li>● Dirt → Wash it away.</li> </ul>

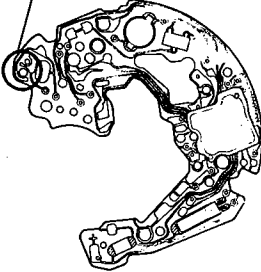
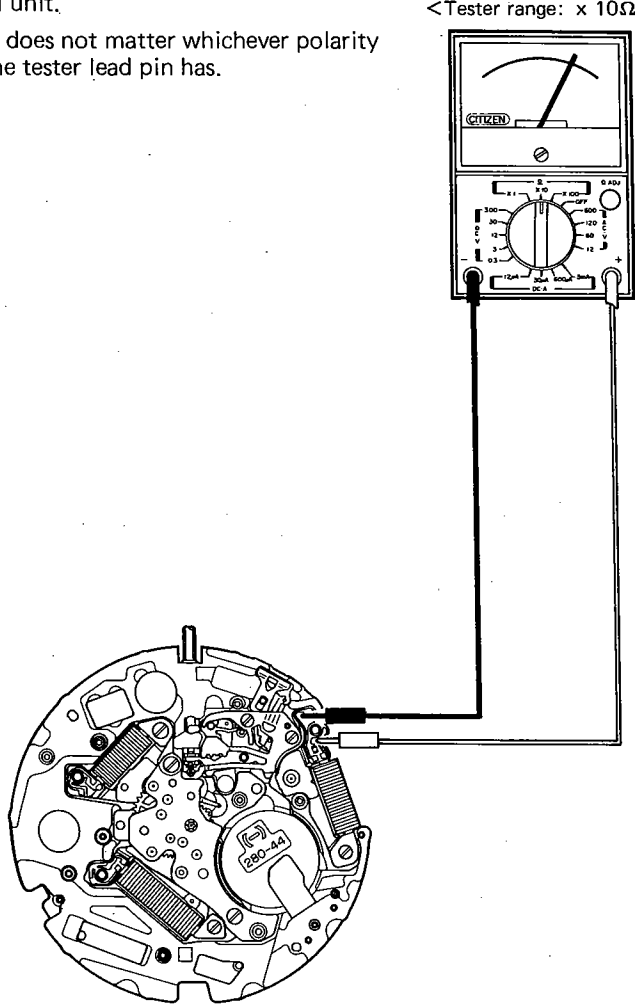
Check points	How to check	Results & treatment
<p><b>10</b> Checking CG connection parts</p>	<p>1) If the screws for chronograph guard are loose, the driving signal may not be transmitted.</p> <p>2) If dust or dirt is found on the coil terminal of the chronograph coil unit or the pattern of the driving signal (A3), a bad transmission of signal will result.</p> <p style="text-align: center;">Pattern of the driving signal (A3)</p> 	<p>1) Loosened screws → Tighten them.</p> <p>2) Dust or dirt → Remove it.</p>
<p><b>11</b> Measuring chronograph coil resistance</p>	<p>Measure resistance of the chronograph coil unit.</p> <p>* It does not matter whichever polarity the tester lead pin has.</p> <p style="text-align: center;">&lt;Tester range: x 10Ω&gt;</p> 	<p>Measuring resistance of the chronograph coil unit:</p> <ul style="list-style-type: none"> <li>● 2.4kΩ ~ 3.0kΩ → Nondefective</li> <li>● Beyond the above range → Replace the chronograph coil unit.</li> </ul>



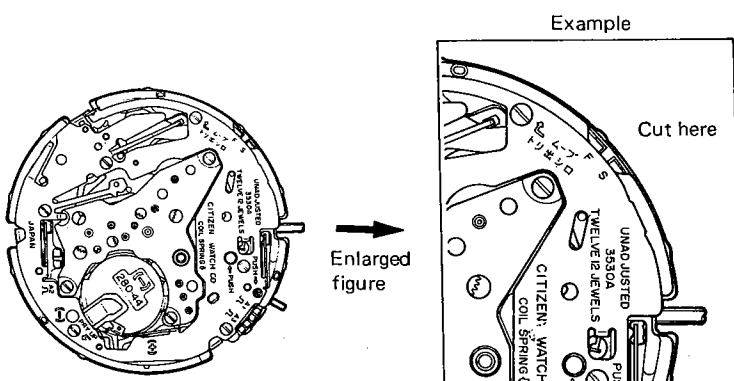

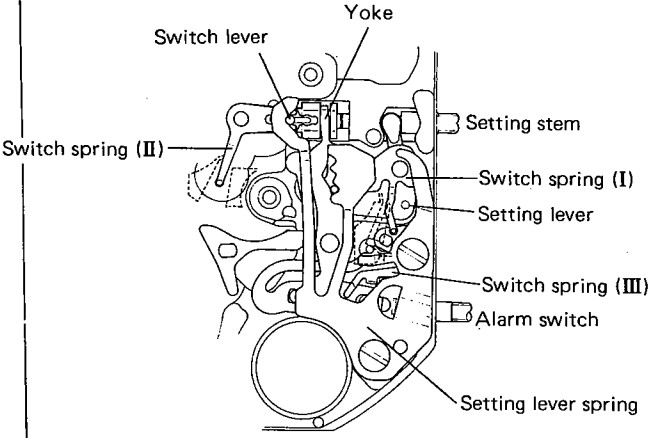
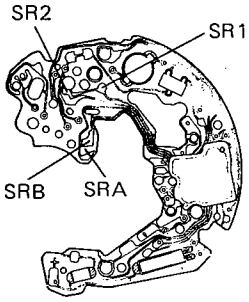
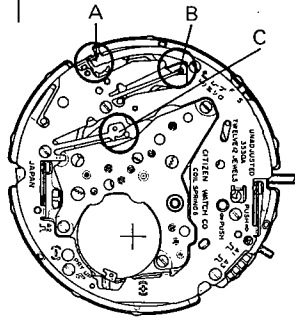
Check points	How to check	Results & treatment
<p><b>12</b> Measuring and adjusting time rate</p>	<p>a. Measuring time rate; This watch employs the D.F.C. (Logic fast and slow adjustment) for measurement. Accordingly, set the measurement range at 10 sec. or its integral multiple.</p> <p>b. Adjusting time rate; If the watch gains or loses time, adjust the time rate by cutting adjustment terminal S or pattern F on the electronic circuit.</p> <div style="text-align: center;">  <p>Example</p> <p>Cut here</p> <p>Enlarged figure</p> </div>	<p>Cut the patterns with a knife.</p> <ul style="list-style-type: none"> <li>● Cutting F alone; → About + 15 sec/month</li> <li>● Cutting S alone; → About - 15 sec/month</li> <li>● Cutting S and F; → About -30 sec/month</li> <li>● The watch still gains or loses substantially even after the patterns are cut. → Replace the electronic circuit.</li> </ul>
<p><b>13</b> Confirming using conditions</p>	<p>Check how the customers use this watch.</p> <ol style="list-style-type: none"> <li>1. Whether they used it beyond the effective temperature range;</li> <li>2. Whether they brought it near intensive magnetism (health band or electric mah-jong table, etc.);</li> <li>3. When was the last time they replaced the power cell;</li> <li>4. When was the last time they set the time;</li> <li>5. Whether they handled it properly or not.</li> </ol>	

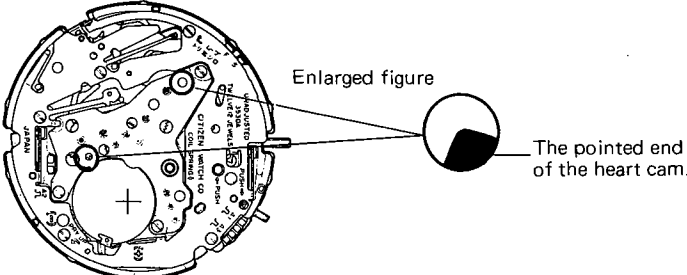
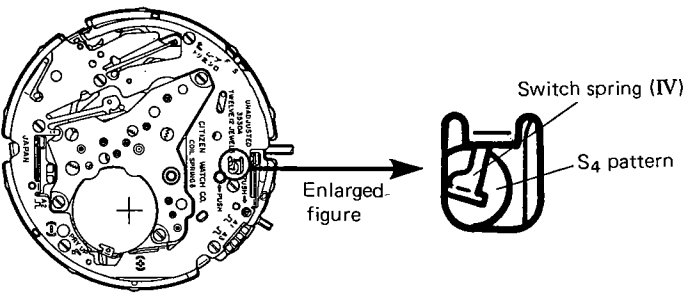
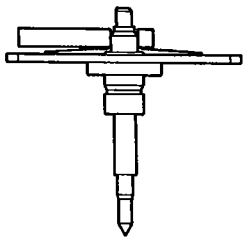
Check points	How to check	Results & treatment
<p><b>14</b> Checking switch mechanism</p>	<p>1. Functions cannot be changed over.</p> <p>a. If the changeover between normal time and also between alarm time correction and normal time correction cannot be carried out, check the following.</p> <p>1) Whether the switch spring (1) has not been deformed;</p> <p>2) Whether there is no dust or dirt where patterns SR1 and SR2 on the back side of the electronic circuit contact with the switch spring (1).</p> <ul style="list-style-type: none"> <li>● If the switch spring (1) makes contact with SR1, alarm time correction is available. .... CAL. 3510/353 ✽</li> <li>● If the switch spring (1) makes contact with SR2, normal time correction is available.</li> </ul> <div style="text-align: center;">  </div> <p style="text-align: right;">(Back side of the electronic circuit)</p> <p>b. When the changeover between the normal time display and the chronograph display is carried out, check the following:</p> <p>1) Whether the button (C) makes a smooth operation and whether it has been deformed;</p> <p>2) Whether the chronograph guard has been properly mounted; It is especially necessary to check that the sections circled in the figure to the right have been properly mounted.</p> <ul style="list-style-type: none"> <li>● The pointed end of the spring of the chronograph guard which is identified as A must not go beyond the operating lever.</li> <li>● The pointed end of the chronograph guard which is identified as B should be put in the groove of the stop connection lever.</li> <li>● The part of the chronograph guard which is identified as C should not rest on the pin of the fly-back connection lever.</li> </ul> <div style="text-align: right;">  </div>	<ul style="list-style-type: none"> <li>● The parts have been deformed. → Return them to their proper shape or replace them.</li> <li>● Dust or dirt → Remove it.</li> <li>● Bad mounting → Mount again.</li> <li>● Bad lubrication → Apply oil again.</li> </ul> <p>Multifunction of the switch mechanism still remains even after checking 4 steps listed above.</p> <p>→ Replace the electronic circuit.</p> <ul style="list-style-type: none"> <li>● Dust or dirt → Remove it.</li> <li>● Apply oil again to the packing of the push button.</li> <li>● The parts have been deformed. → Replace the parts.</li> <li>● Bad mounting → Mount again.</li> </ul> <div style="text-align: right;">  </div>

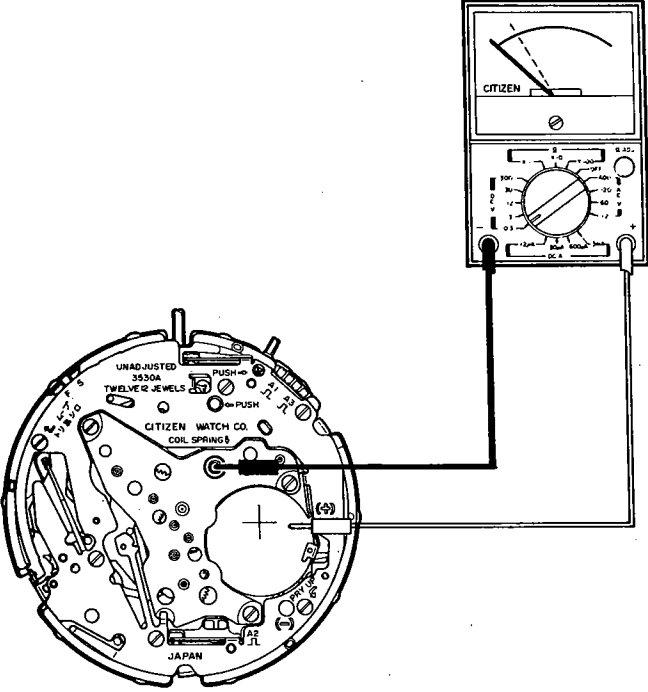
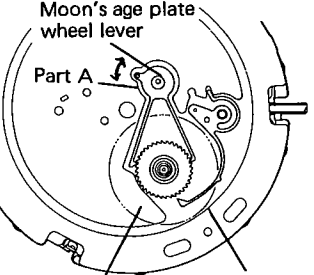
Check points	How to check	Results & treatment
	<p>3) Confirm that the hour-recording wheel and the minute-recording wheel have been properly mounted.</p> <p>A simple confirmation is made as follows;          If the pointed end of the heart cam is found located in the center of the round hole on the chronograph guard, as shown in the figure below, the mounting has been properly made.</p>  <p>4) Confirm that there is no dust or dirt on the pointed end of the switch spring (IV) and on pattern S4 of the electronic circuit.</p>  <p>5) Check the operating lever, pillar wheel, lever for pillar wheel, stop connection lever, switch spring (IV) and fly-back connection lever in terms of the following;</p> <p>* Whether the parts have been properly mounted;          Whether they have been deformed;          Whether they are fully lubricated.</p> <p>6) Confirm that the hour-recording wheel and the minute-recording wheel have been fully lubricated.</p> <p>A special confirmation is necessary to see whether lubrication has been fully made between the heart cam and the ratchet spring.</p> 	<ul style="list-style-type: none"> <li>● Bad mounting → Mount again.</li>   <li>● Dust or dirt → Remove it.</li>   <li>● Bad mounting → Mount again.</li> <li>● Deformed parts → Replace them.</li> <li>● Bad lubrication → Apply oil again.</li> <li>● Bad lubrication → Apply oil again.</li> </ul>

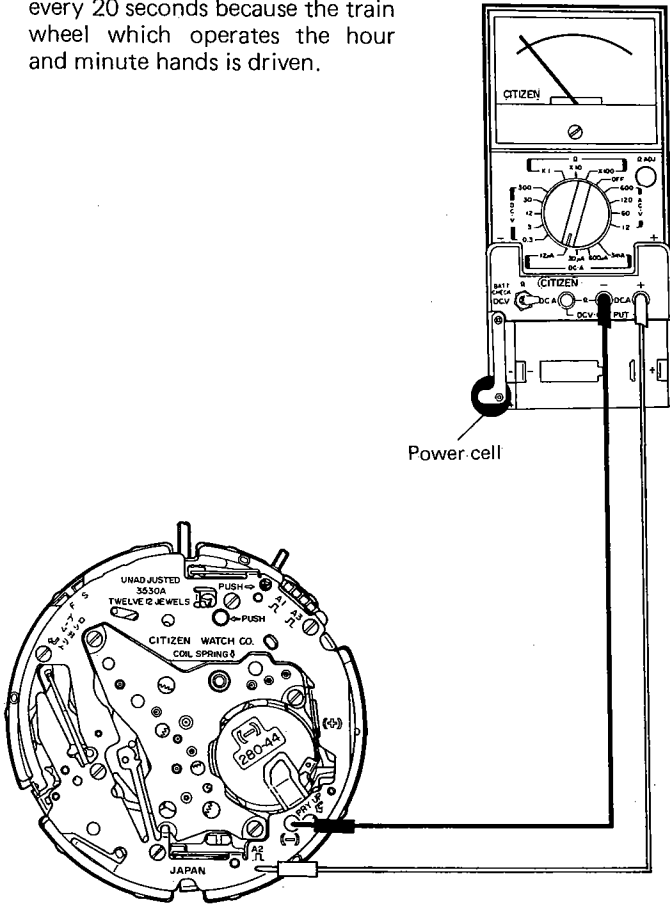
Check points	How to check	Results & treatment
<p><b>15</b> Checking alarm mechanism (Cal. 351*/353*)</p>	<p>1. Confirm alarm output Make a measurement using the alarm monitor as shown in the figure.</p> <p>* Alarm monitor If the alarm switch is quickly operated in order of ON → OFF → ON in a second in the normal time display, the alarm monitor is activated and sounds for 5 seconds.</p> <p>If this method is not possible because there is not enough time, make a measurement with the alarm sounding (for 20 seconds) by setting the alarm time.</p> <p style="text-align: center;">&lt;Tester range: D.C. 0.3V &gt;</p>  <p>2. Confirm the assembled parts</p> <ul style="list-style-type: none"> <li>• Whether the buzzer contact spring has been properly mounted.</li> <li>• Whether there are no cracks or cuts on the piezo-electric element (white) which has been directly attached against the inside of the case back.</li> </ul>	<ul style="list-style-type: none"> <li>• The tester pointer swings. → Nondefective</li> <li>• The tester pointer does not swing. → Replace the electronic circuit.</li> </ul>
<p><b>16</b> Checking calendar mechanism (CAL. 3510*/3560*) /age of the moon mechanism (Cal. 3570*)</p>	<ul style="list-style-type: none"> <li>• Check of calendar mechanism See Basic Course II-2-c.</li> <li>• Check of age-of-the-moon mechanism Confirm that the moon's age plate wheel lever, moon's age plate and moon's age corrector lever are assembled correctly. Check the parts including the moon's age plate wheel lever etc. for deformation.</li> </ul>	 <p style="text-align: center;">Moon's age plate wheel lever Part A Moon's age plate Moon's age corrector lever</p>

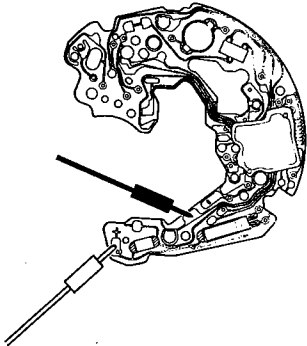
Check points	How to check	Results & treatment
<p><b>17</b> Measuring current</p>	<p>1. Measurement in the normal time display (with the second hand running)</p> <ul style="list-style-type: none"> <li>● Measure the completed module for current.</li> </ul> <p>Current value rises in a moment every 20 seconds because the train wheel which operates the hour and minute hands is driven.</p> <p style="text-align: right;">&lt;Tester range: D.C. 12<math>\mu</math>A&gt;</p>  <p>2. Measurement when the chronograph is operating.</p> <p>Measure the completed module for current.</p> <ol style="list-style-type: none"> <li>In this measurement, current value indicates around 70<math>\mu</math>A under normal conditions.</li> </ol> <p>Accordingly, the tester range should be set at 600<math>\mu</math>A.</p> <ol style="list-style-type: none"> <li>After showing the chronograph display, press the switch which corresponds to the (A) button to cause the CG 2/100 sec. hand to run. That is to say, current should be measured after the train wheel is driven.</li> </ol> <p>The CG 2/100 sec. hand automatically stops running after 3 minutes. Accordingly, make a measurement within 3 minutes after the start.</p> <ol style="list-style-type: none"> <li>Where to measure is described in the above figure.</li> </ol>	<p>1. With the second hand running</p> <ul style="list-style-type: none"> <li>● Under 3.0<math>\mu</math>A → Nondefective</li> <li>● Over 3.0<math>\mu</math>A → Proceed to item No. 3. Measure the electronic circuit singly.</li> </ul> <p>2. When the chronograph is operating. (When the CG 2/100 sec. hand is running.)</p> <ul style="list-style-type: none"> <li>● Under 80<math>\mu</math>A → Nondefective</li> <li>● Over 80<math>\mu</math>A → Check train wheel.</li> </ul> <p>* Make a check on the CG additional rotor, intermediate CG sec. wheel and CG sec. wheel.</p>

Check points	How to check	Results & treatment
	<p>3. Measure the electronic circuit singly. Where to measure is illustrated below. Set the tester range at <math>12\mu\text{A}</math>.</p> 	<p>3. Measure the electronic circuit singly.</p> <ul style="list-style-type: none"> <li>● Under <math>0.5\mu\text{A}</math> → Check the train wheel.</li> <li>● Over <math>0.5\mu\text{A}</math> → Replace the electronic circuit.</li> </ul>
<p>17 Checking appearance and functions</p>	<p>Check the following;</p> <ul style="list-style-type: none"> <li>● Whether there is nothing wrong with the appearance;</li> <li>● Whether the crown, alarm switch and each button correctly operate;</li> <li>● Whether alarm (alarm monitor) sounds.</li> </ul> 	

**CITIZEN WATCH CO., LTD.**

Tokyo, Japan